

essentials.



WORKSHOP
CATALOGUE

prooptica®
full eyewear concept

essentials.

Prooptica Essentials is a brand of equipment and tools for optician's workshops that is based on the trends and needs of the most diverse market in the world to offer a **diversified and qualitative product portfolio**.

The know-how in the production and manufacture of optical products is one of the main reasons that allows the brand to combine the quality of the offer at the best price with a broad and objective portfolio.

The ease of ordering and the transparent price assure agility and efficiency in the logistics process.



machines



tools



**measuring
devices**



frame parts



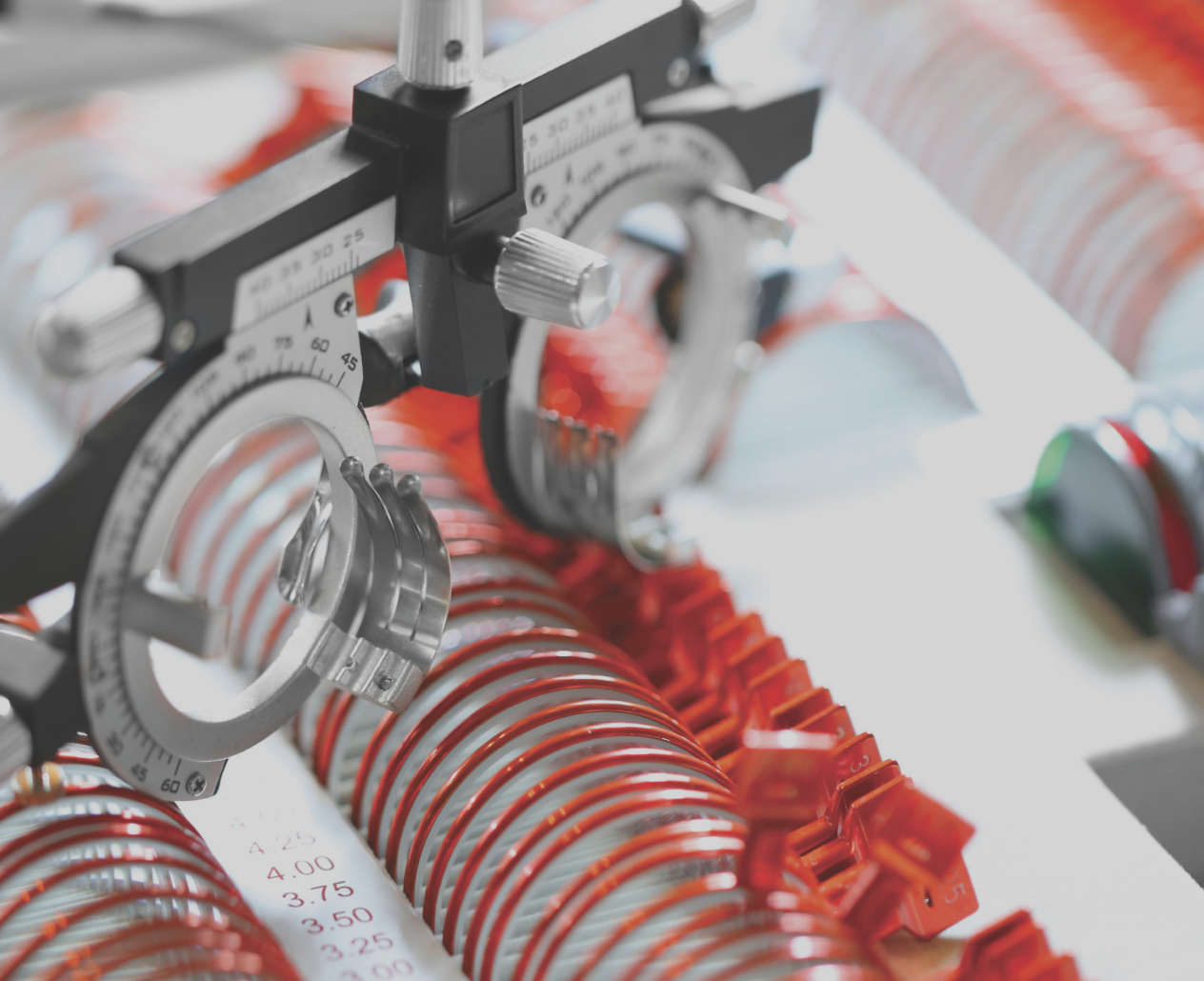

CONTENTS



machines

- 08 AUTO LENS METER
- 09 LENS GROOVER
- 10 DIGITAL PUPILOMETER
MECHANICAL PUPILOMETER
- 11 HAND EDGER
- 12 HAND EDGER - FINE GRAIN
LENS DRILLING MACHINE
- 13 ULTRASONIC CLEANING DEVICES
PHOTOCHROMIC LENS TESTERS
- 14 FRAME HEATERS



tools

- 18 PLIERS STAND
- 19 PLIERS
- 29 TOOL ASSORTMENTS
- 31 DISASSEMBLY PLIERS
TWEEZERS
- 32 SCREWDRIVERS
- 33 SCREWDRIVER SETS
- 34 NUTDRIVERS
- 35 NUTDRIVER SETS AND NUT HOLDER
MEASUREMENT TOOL FOR HOLES
- 36 DRILLS
- 38 MILLERS
- 39 DRILLS AND MILLER SET



measuring devices

- 42 LENS CLOCKS
THICKNESS GAUGES
CALIPERS
- 43 TRIAL LENS SET
- 44 TRIAL FRAMES



frame parts

NOSE PADS

- 49 NOSE PAD ASSORTMENTS
- 51 SPARE KIT WORKS FOR RAYBAN FRAMES
- 52 SILICONE NOSE PADS WITH PLASTIC INSERT
- 55 SILICONE NOSE PADS WITH METAL INSERT
PRIMADORA NOSE PADS - SILICONE
- 56 SILICONE AIR PAD CUSHIONS
- 57 SILICONE SOFT PADS
- 58 SILICONE SADDLES
- 59 SILICONE NOSE BRIDGES WITH METAL INSERT
- 60 PVC NOSE PADS
- 62 POLYCARBONATE ULTRA SLIM, HARD, LONG-LASTING, DURABLE
- 63 TRANSPARENT NOSE PADS WITH METAL INSERT- WORKS FOR RAYBAN FRAMES
- 64 TITANIUM NOSE PADS
- 65 NOSE PADS CUSHIONS
- 67 PAD ARMS

SCREWS & NUTS

- 69 SCREW ASSORTMENTS
- 70 WASHER ASSORTMENTS
- 71 POP OFF! SCREWS
- 73 SELF-TAPING SCREWS
- 74 SELF ALIGNING SCREWS
- 75 HINGES SCREWS
- 77 NOSE PADS SCREWS
- 78 RIM JOINT SCREWS
- 79 RIMLESS FRAME SCREWS
- 80 NUTS

WASHERS & SLEEVES

- 81 WASHERS
- 82 SLEEVES
- 83 HINGES

TEMPLES

- 86 TEMPLE TIP ASSORTMENT
- 87 TEMPLE ENDS
- 91 METAL TEMPLES
- 93 ACETATE TEMPLES
- 96 FRAME PARTS FOR RIMLES FRAMES
- 100 SILICONE NON SLIP TEMPLE ENDS
- 101 NON-SLIP EAR HOOKS
NON-SLIP TEMPLE ENDS
- 102 NYLON THREADS
LENS LINERS

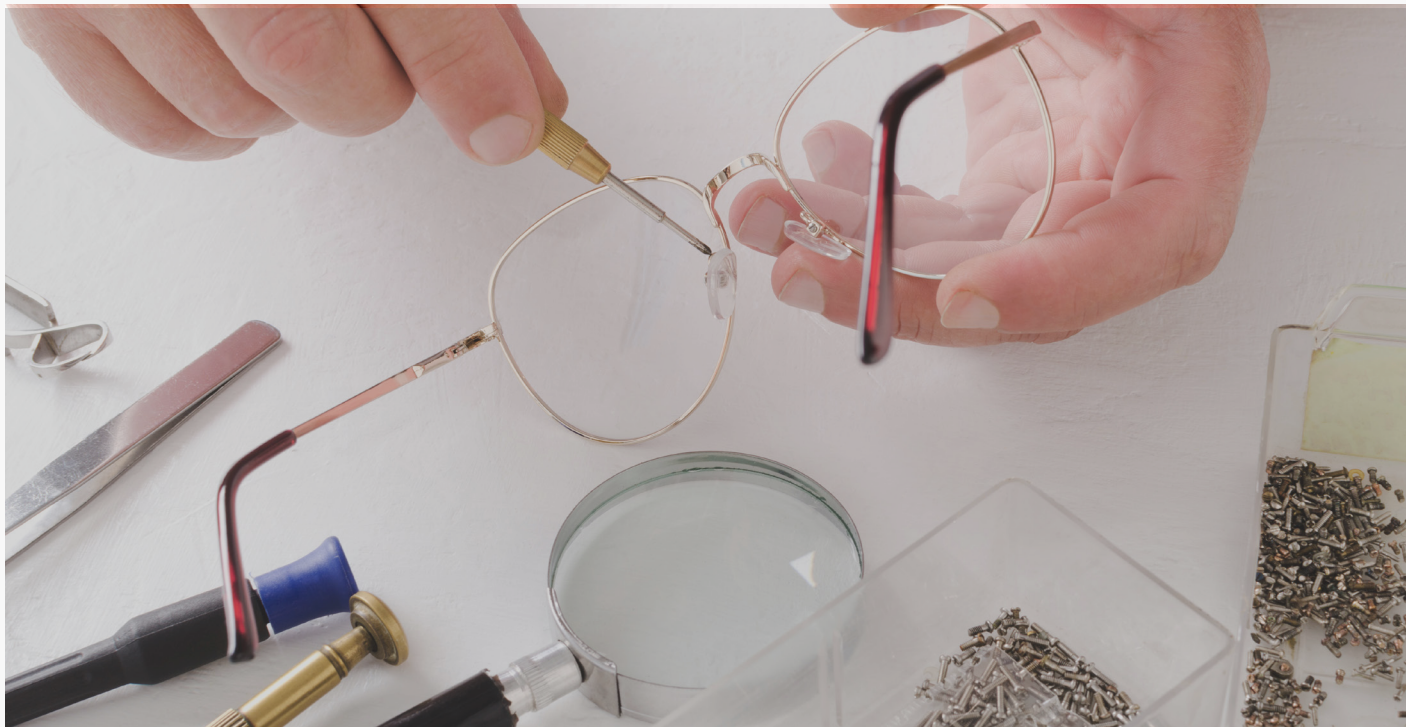

machines

- 08 AUTO LENSMETER
- 09 LENS GROOVER
- 10 DIGITAL PUPILOMETER
MECHANICAL PUPILOMETER
- 11 HAND EDGER
- 12 HAND EDGER - FINE GRAIN
LENS DRILLING MACHINE
- 13 ULTRASONIC CLEANING DEVICES
PHOTOCHROMIC LENS TESTERS
- 14 FRAME HEATERS





AUTO LENSMETER

D903A // 222x161x372 mm / 5kg

- Adjustable & sensitive touch LCD display screen
- Progressive measurement
- Automatic recognition of single and progressive lens
- Hi-speed UV measurement
- Built-in thermal printer
- Built-in UV tester
- Packed in aluminum metal case

Measure scope

Sphere // 0~±25D 0.01/0.12/0.25D steps

Cylinder // 0~±9.99D 0.01/0.12/0.25D steps

Axis // 0°~180° (1°step)

ADD // 0~+9.99D 0.01/0.12/0.25D steps

Prism degree // 0~15△ 0.01/0.12/0.25△ steps

Measurement Mode

Cylinder // +, +/-, -

Prism // X-Y, P-B

Contact lens // Soft/Hard

Measuring mode // Single/Progressive

Specification

Diameter of lens // ϕ 20~108mm

PD // 40~90mm, 0.25mm steps

Speed // 0.1S

Display // TFT LCD (7")

Power supply // 200~220V 50/60Hz



• Built-in UV tester



LENS GROOVER

NH-800ATG // 270x210x150 mm / 2.7kg

- Improving the structure of grooving table based on origin, the grooving length has been increased greatly.
- Suitable for modern and fashion eyeglasses
- No grooving deformation by improving the lens chuck
- Adjustable groove depth
- Improving on the angle of cutter wheel guarantee the steady of grooving
- No water system required
- Accurate on all profiles

Depth of Groove // 0-0.7mm

Width of Groove // 0.65mm

Lens Thickness // 1.5mm-11mm

Lens Size Range // 18mm-70mm

Grooving Time // Approx. 60 seconds

Power Supply // 200-240V 50Hz, 90W

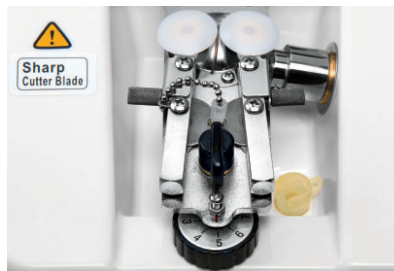

DIAMOND GROOVING WHEEL

100520

To be used with item number 100530 / NH-80ATG

Outer Diameter // 25mm

Width of Groove // 0.55mm



machines



Measuring window
Simultaneous display of
left, right and combined
PD measurements

On/Off switch

Right pupil
measuring slide



Forehead distance bar

Switch between PD and
vertex measurement

Left pupil
measurement slide

Focal distance
adjuster: 30cm-∞

PD measurements
On/Off switch

DIGITAL PUILOMETER

CP-32A // 320x230x110 mm / 800g

- PD meter with LC display and focusing light circle to ensure easy reading.
- Both monocular and binocular measurements possible.

Data Range // Binocular PD: 45 – 82mm
// Monocular PD: 22.5 – 41mm

Distance Range // 30cm – infinity

Indication error // =< 0.5mm

Rounding error // =< 0.5mm

Asymmetric Error // =< 0.5mm

Automatic Standby // 1 minute

MECHANICAL PUILOMETER

BRT-3 // 220x160x60 mm / 600g

- Pupil distance measure.
- Eye wire distance measure.
- Pupil height measure.
- SPH +2.00D compensation available

Data Range // Binocular PD: 46 – 82mm
// Monocular PD: 23 – 41mm

PH // 12 – 28mm

LD // 6 – 20mm

Distance range // 300mm – infinity

Indication error // =< 0.5mm

Rounding error // =< 0.5mm

Asymmetric error // =< 0.5mm

Automatic Standby // 2 minutes



HAND EDGER

NH-35W // 360x200x288 mm / 8kg

- Diamond wheel : 35mm
- Rough and fine grinding
- Water tank, valve (with sponge) and drain system
- Sponge holder
- Dual switch for wheel orientation
- High power aluminium housing motor

Power Supply // 200-240V, 50Hz



machines

DIAMOND WHEELS FOR EDGERS

For plastic lenses (not for mineral lenses)

100640

Width of Groove // 18mm

Overall Diameter // 90mm

Hole Diameter // 19 mm

Mesh // 70-80

Briot type roughing wheel

100642

Width of Groove // 17mm

Overall Diameter // 100mm

Hole Diameter // 20mm

Mesh // 70-80

Nidek type roughing wheel

100644

Width of Groove // 15mm

Overall Diameter // 155mm

Hole Diameter // 20mm

Mesh // 70-80

Essilor type roughing wheel

100641

Width of Groove // 20 mm

Overall Diameter // 110 mm

Hole Diameter // 19 mm

Mesh // 70-80

Briot type roughing wheel

100643

Width of Groove // 22 mm

Overall Diameter // 100 mm

Hole Diameter // 20 mm

Mesh // 70-80

Nidek type roughing wheel



100640



100641



100642



100643



100644

HAND EDGER - Fine Grain

NH-100W // 260x180x180 mm / 3.7kg

- Hand edger for chamfering and polishing mineral/organic lenses

Features:

- Conical diamond wheel from 56 to 98 mm in diameter
- Retouching mini bevels with either the left hand or the right hand side of the wheel.
- Good adding and draining water system
- Invisible removable water tank
- Reversible switch

Power Supply // 100-120V, 60Hz 200-240V,50/60Hz,75W

Standard wheel option:

- **100W** // 400/500mesh, Rough, fine grinding

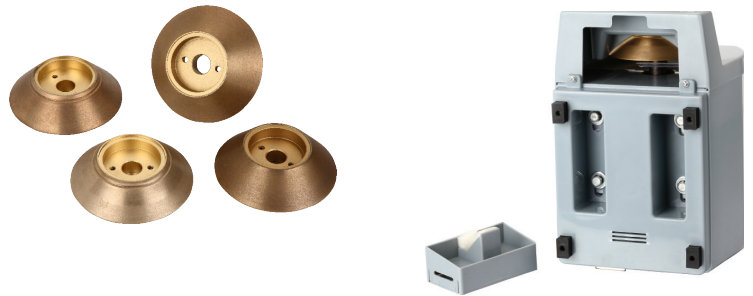

LENS DRILLING MACHINE

CP-2AT

- Ideal for drilling holes in glass and plastic lenses
- Opposing taper drill bits system allow holes to be drilled from both sides simultaneously for precise place and avoids chipping and breaking of all lenses, especially those made of glass
- After hole drilled, placed the lens under reamer and lifted upwards to be enlarged to desired size



ULTRASONIC CLEANING DEVICE

CP-17A // 240x210x210 mm / 2.5kg

- Remarkable cleaning effect, small volume, large power, easy to use
- It is equipped with sound water-proof system

Power / 220V, 60/50HZ, 17A/50W



ULTRASONIC CLEANING DEVICE

CP-113T // 240x210x210 mm / 2.5kg

- Remarkable cleaning effect, small volume, large power, easy to use
- It is equipped with sound water-proof system
- Timer

Power / 220V, 60/50HZ, 17A/50W



PHOTOCHROMIC LENS TESTER

WB-2214D

Lamp // 15 LED

Power // 24W

Wave length // 365 – 405nm

Timer // 30/60seg



PHOTOCHROMIC LENS TESTER

CP-18C

- UV-400 test
- Transmittance test
- Radiation Resistant test





FRAME HEATER

NEW!

CP-19T

- Ceramic heating system and non-flammable make the life more longer
- Electronic temperature regulator and low-noise electric air fan

Rated Power // 500W

Heating temperature range // 80-160 degree



CP-19C

- Heating coil

Rated Power // 500W

Heating temperature range // 80-160 degree



YK-101 // 235x125x250 mm / 1.66kg

- Heating coil

Rated power // 500W

Heating temp. (Max) 110°C

Temp 1: 80°C

Temp 2: 100°C

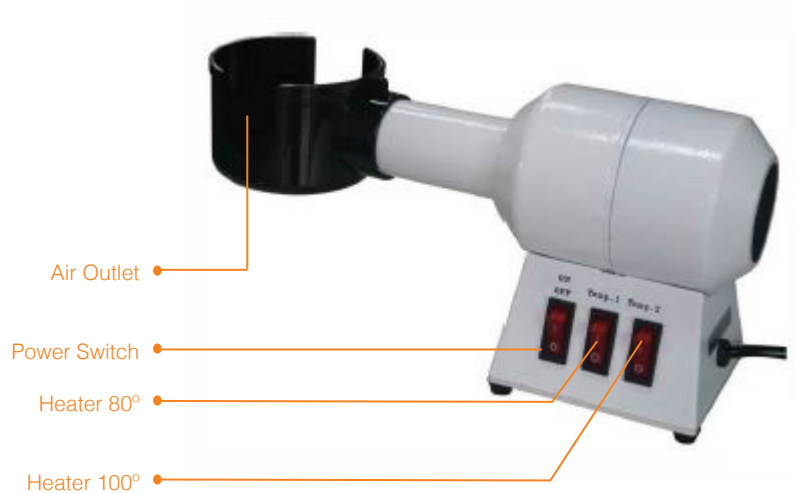







tools

- 18 PLIERS STAND
- 19 PLIERS
- 29 TOOL ASSORTMENTS
- 31 DISASSEMBLY PLIERS
TWEEZERS
- 32 SCREWDRIVERS
- 33 SCREWDRIVER SETS
- 34 NUTDRIVERS
- 35 NUTDRIVER SETS AND NUT HOLDER
MEASUREMENT TOOL FOR HOLES
- 36 DRILLS
- 38 MILLERS
- 39 DRILLS AND MILLER SET

PLIERS

Prooptica Essentials' plier range is meticulously checked to ensure quality levels are maintained, including uniform sizes and smooth operations. Replacement jaws are readily available and easy to use, allowing for longevity.



tools

PLIERS STAND

200930 // 180 x 110 x 100 mm / 385 g

Stand only, contents not included.



HOLDING PLIERS

200110 // 1 piece / 148 mm / 110 g

With plastic jaws 6mm

200111 // 1 pair / 6 mm

Replacement plastic jaws



HOLDING PLIERS

200120 // 1 piece / 148 mm / 100 g

With plastic jaws, jaw mouth remains in parallel position up to approx. 3mm

200121 // 1 pair / 6 mm

Replacement plastic jaws



FLAT NOSE PLIERS

200210 // 1 piece / 148 mm / 95 g

3 mm width at tip



tools



tools

FLAT SNIPE NOSE PLIERS

200220 // 1 piece / 148 mm / 110 g

Semi-circular jaws



 \varnothing 1.5 mm

ROUND SNIPE NOSE PLIERS

200230 // 1 piece / 148 mm / 110 g

Round jaw



PAD ADJUSTING PLIERS

200310 // 1 piece / 147 mm / 110 g

Delicate pliers used to avoid touching the lens during fitting. For "push in" style nose pad.



NOSE PAD REMOVING PLIERS

200320 // 1 piece / 150 mm / 110 g

Removes "clip on" style nosepad.



PAD ADJUSTING PLIERS FOR SCREW IN NOSE PAD

200330 // 1 piece / 148 mm / 100 g



NOSE PAD ARM CUP ADJUSTING PLIERS

200340 // 1 piece / 120 mm / 50 g

Long tinny tip , easy adjusting the pad arm cup

NEW!

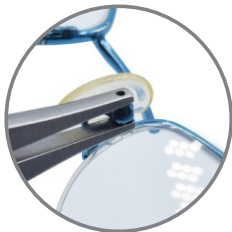

tools



tools

INCLINATION PLIERS (Conical)

200410 // 1 piece / 148 mm / 105 g

Conical jaw: 6:1.5mm diameter

200411 // 1 piece / 8 mm

Replacement plastic jaw



NYLON EYEWIRE SHAPER

200510 // 1 piece / 145 mm / 110 g

With plastic jaws (24 mm)

200511 // 1 pair / 24 mm

Replacement plastic jaw



BENDING PLIERS WITH 3 ROLLERS

200520 // 1 piece / 148mm / 100g

For various purposes : to adjust frames, bridges, temples, and temple tips

200521 // 1 set

Replacement pastic jaw for 200520



TRIDENT PLIERS

200530 // 1 piece / 137 mm / 100 g

Allow precise and easy adjustment of "clip on" bridge.



BENDING PLIERS

200540 // 1 piece / 140 mm / 100 g

Allow fine adjustments, and prevents scratching. Width of jaw 9.5mm.

200541 // 1 piece / 9.5 mm

Replacement plastic jaw



PAD ARM ADJUSTING PLIERS

200550 // 1 piece / 148 mm / 100 g

Curved pliers jaws feature tiny grooves for a firm grip.

For safe adjustment of pad arms.



tools



tools

PEENING PLIERS

200610 // 1 piece / 138 mm / 95 g

Peening tip and point shaped sunken anvil prevent marking the frame.

200611 // 1 piece

Replacement peening tip



SIZE TESTING PLIERS

200620 // 1 piece / 139 mm / 110 g

For testing lens' size during the finishing process.



HINGE SETTING OR ANGLING PLIERS

200630 // 1 piece / 137 mm / 135 g

Has 2 concave indentations and parallel mouth, opens at 1mm. width of mouth: 4mm.



HINGE PLIERS

NEW!

200640 // 1 piece / 140 mm / 110 g

Works for both normal hinge temple hinge and Silhouette frame temple hinge adjusting without scratch.

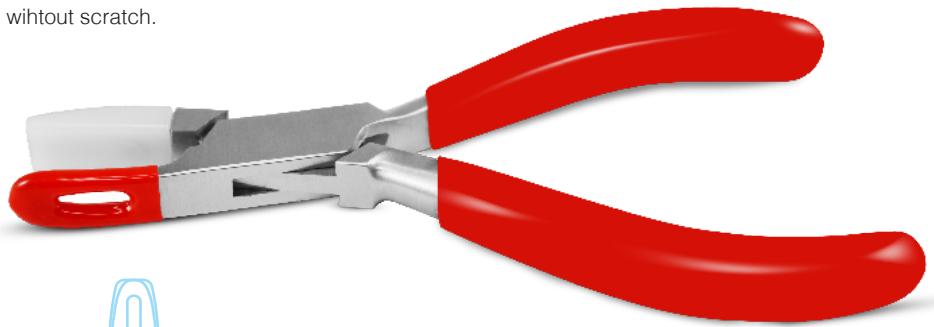

LENS ALIGNER

200710 // 1 piece / 190 mm / 175 g

Two 20mm discs with grooves, and a spring mechanism on the handle.

200711 // 1 pair / \varnothing 20 mm

Replacement rubber discs



FRONT CUTTER FOR PLASTIC SLEEVE

200810 // 1 piece / 137 mm / 95 g

For cutting plastic sleeves on frames.

Special shape reduces danger of scratching.

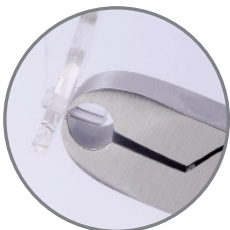

tools

SIDE CUTTER

200820 // 1 piece / 145 mm / 108 g

For stainless steel up to a maximum of 1.6 mm, with plastic grip protection.



SCREW CUTTER

NEW!

200840 // 1 piece / 127 mm / 120 g

For stainless steel screw up to a maximum of 1.4mm with plastic grip protection .

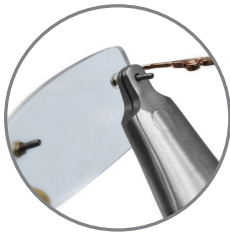

OB CUTTER

200830 // 1 piece / 135 mm / 100g

Cuts nickel silver screws and rivets. Design allows flush cuts in tight areas

Note: Does not cut stainless steel.

Great cutting tool for all of soft material screws.

Does not cut stainless steel screws.

- Unique improved spring for smooth action
- Ergonomic angle
- Induction hardened edge



PRESSING PLIERS

200900 // 1 piece / 140 mm / 110 g

For pressing in plastic sleeves on rimless frames.

Width of jaw 8mm.

200901 // 1 pair / 8 mm

Replacement plastic jaws



PLIERS FOR SCREWLESS RIMLESS FRAMES

200910 // 1 piece / 137 mm / 95 g

With two notches for easy disassembly of screwless frames.



PRESSING PLIERS FOR RIMLESS FRAMES

200920 // 1 piece / 148 mm / 100 g

For pressing out plastic sleeves from drill holes

200921 // 1 pair

Replacement plastic jaws



tools

RIMLESS FRAME ADJUSTING PLIERS

200940 // 1 piece / 148 mm / 100 g

Specially for aligning rimless frames.

Secure grip of the screws and nuts

200941 // 1 piece

Replacement plastic jaws for 200940



tools

D BLOCKING PLIERS

2001010 // 1 piece / 140 mm / 110g

For easy removal of NIDEK lens blocks made of plastic vertical

NEW!





Customisable

Pressing pliers 200920 can be replaced by 200120 or 200410

Front cutter 200810 can be replaced by 200910 or 200530

Flat nose pliers 200210 can be replaced by 200230 or 200220

For details please contact us



tools

TOOL ASSORTMENT

201001 // 1 set / 230 x 180 x 45 mm (w x l x h)

includes:

SCREW HOLDING TWEEZERS

300130 // 1 piece

TWEEZERS

for removal of "clip-on nose pads"

300131 // 1 piece

UNIVERSAL SCREWDRIVER

without blade

300300 // 1 piece

OPTICAL NUTDRIVER

without blade

300420 // 1 piece

BLADE FOR SCREWDRIVER

// 6 piece

⊕ 1.5, 2.0 mm

● 1.0, 1.4, 1.8, 2.3 mm

TRANSPARENT PD RULER

400430 // 1 piece

PRESSING PLIERS

for rimless frames

200920 // 1 piece

FRONT CUTTER

for plastic sleeves

200810 // 1 piece

FLAT NOSE PLIERS

200210 // 1 piece

BLADE FOR NUTDRIVER

// 8 piece ○ 2.0, 2.2, 2.3, 2.6 mm

⊙ 2.0 mm

⊗ 2.1, 2.2, 2.6 mm

TOOL SET

201002 // 1 set / 530 pieces / 270 x 160 x 50 mm (w x l x h)

includes:

INCLINATION PLIERS (Conical)

200410 // 1 piece

HOLDING PLIERS

200110 // 1 piece

PAD ADJUSTING PLIERS

200310 // 1 piece

HINGE SETTING OR ANGLING PLIERS

200630 // 1 piece

SCREW HOLDING TWEEZERS

300130 // 1 piece

TWEEZERS

300131 // 1 piece

UNIVERSAL SCREW DRIVER

300300 // 1 piece

With Four Blades

NUT HOLDER

200950 // 1 piece

TRANSPARENT PD RULER

400430 // 1 piece

SMALL 7 COMPARTMENT ORGANISER

S000030 // 1 piece

NOSE PAD, SILICONE

501102-14.5P // 10 piece

Symmetrical, Push In

NOSE PAD, SILICONE

501102-13S // 10 piece

Symmetrical, Screw In

NOSE PAD SCREW

50380410100 // 100 piece

Slotted Screw, Silver

HINGE SCREW

50360410100 // 100 piece

Slotted Screw, Silver

RIM JOINT SCREW

50370410100 // 100 piece

Slotted Screw, Silver

SELF ALIGNING SCREW

50340410100 // 100 piece

for Spring Hinges, Slotted Screw, Silver

SELF ALIGNING SCREW

50340210100 // 100 piece

for Spring Hinges, Slotted Screw, Silver

Tool Kit Bag

S000050 // 1 piece



DISASSEMBLY PLIERS

300610 // 2 pieces / 75 x 25 x 10 mm / 7 g each

Fits for all frames with 1.4 and 1.8 pins and standard drill hole distance.



Applicable to
1.4 mm Pins



Applicable to
1.8 mm Pins

SCREW HOLDING TWEEZER

300130 // 1 piece / 130 mm / 20 g

With grooves on both tips to hold pad screws and other small items.

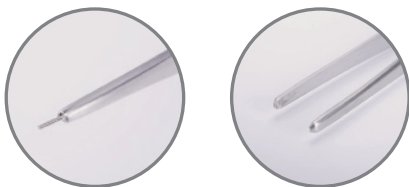

TWEEZER

300131 // 1 piece / 100 mm / 15 g

For removal of "clip-on nose pads".
Also available as pliers (200320) .

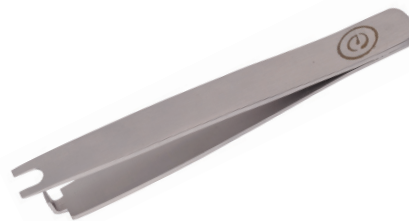

SOLDER TWEEZERS

300132 // 1 piece / 165 mm / 35 g

With insulated grip for safety.



300133 // 1 piece / 165 mm / 35 g

With insulated grip for safety.



tools

OPTICAL SCREWDRIVERS

Screwdriver // 1 piece / 29 g each

Spare Wing Blade // 3 pieces

Shaft Size // 3.0 mm

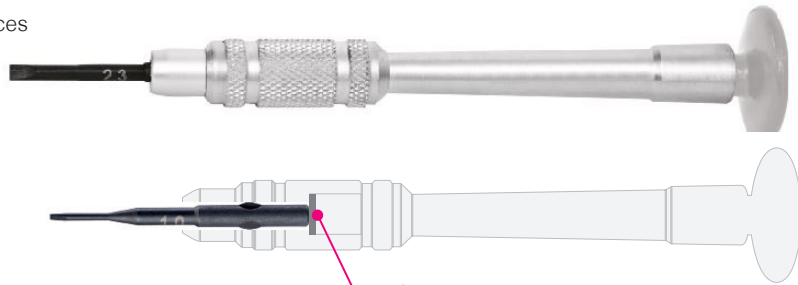

* Subject to availability
We are updating our stocks
All new holders will be with magnet



300200 // \oplus 2.0 mm
30020001 Spare Wing Blade



300210 // \ominus 1.0 mm
30021001 Spare Wing Blade



300214 // \ominus 1.4 mm
30021401 Spare Wing Blade



300215 // \oplus 1.5 mm
30021501 Spare Wing Blade



300216 // \ominus 1.6 mm
30021601 Spare Wing Blade



300218 // \ominus 1.8 mm
30021801 Spare Wing Blade



300223 // \ominus 2.3 mm
30022301 Spare Wing Blade



300240 // \oplus 1.8 mm
3002401 Spare Wing Blade

SCREWDRIVER SETS

300261

Rotating Aluminium Stand with 6 pcs Screwdrivers. *



300262

Plastic Stand with 6 pcs Screwdrivers. *



* We can mix screwdrivers and nutdrivers in one stand
Please contact with us for MOQ

UNIVERSAL SCREWDRIVER

with four blades

300300 // 32 g with 4 blades

Long handle for easy grip.



⊕ 1.5 mm



● 1.0 mm



● 1.4 mm



● 1.8 mm



tools

OPTICAL NUTDRIVERS

Nutdrivers // 1 piece / 29 g each

Spare Wing Blade // 2 pieces

Shaft Size // 3.0 mm

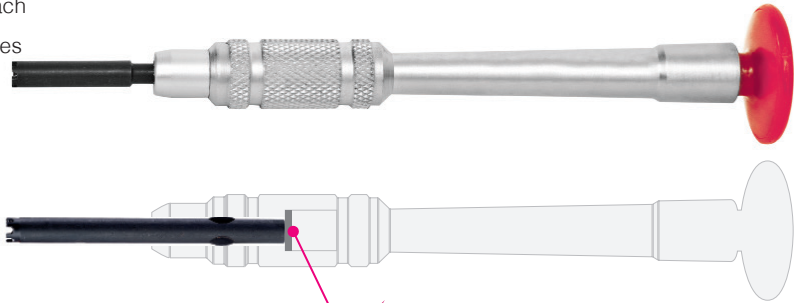

*Subject to availability
We are updating our stocks
All new holders will be with magnet

⚡ Magnet Holder Inside*



300420 // ⬡ 2.0 mm
30042001 Spare Wing Blade



300422 // ⬡ 2.2 mm
30042201 Spare Wing Blade



300423 // ⬡ 2.3 mm
30042301 Spare Wing Blade



300425 // ⬡ 2.6 mm
30042501 Spare Wing Blade



300428 // ◻ 2.0 mm
30042801 Spare Wing Blade

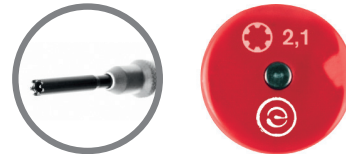

300430 // ◻ 2.1 mm
30043001 Spare Wing Blade



300435 // ◻ 2.2 mm
30043501 Spare Wing Blade



300438 // ◻ 2.6 mm
30043801 Spare Wing Blade



3004252 // ◻ 2.52 mm
30042521 Spare Wing Blade



3004282 // ◻ 2.82 mm
30042821 Spare Wing Blade

NUTDRIVER SETS

300471

Rotating Aluminium Stand with 8 pcs Nutdrivers. *



300472

Plastic Stand with 8 pcs Nutdrivers. *



* We can mix screwdrivers and nutdrivers in one stand
Please contact with us for MOQ

NUT HOLDER

200950 // 1 piece / 110 mm / 35 g

Allows easy pick up of nuts and facilitates easier fitting of nuts to the thread.



MEASUREMENT TOOL FOR HOLES

301310 // 1 piece / 65 mm / 10 g

Easy and quick measuring of hole sizes including lenses.
With rounded tips for easy handling.

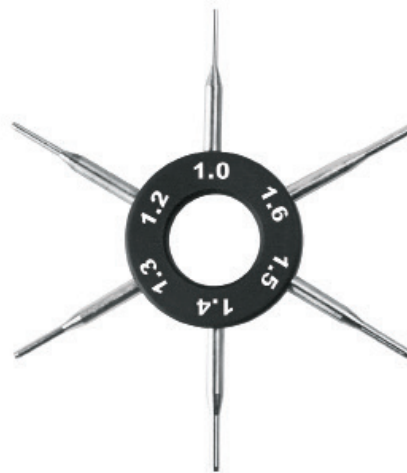

SPIRAL HSS DRILLS

3011... // 1 piece

With cylinder shaft, right cut

Working speed: 500 to 3,000rpm

Field of application: Plastic materials and precious metals.



0.5 mm	301105
0.6 mm	301106
0.7 mm	301107
0.8 mm	301108
0.9 mm	301109
1.0 mm	301110
1.1 mm	301111
1.2 mm	301112
1.3 mm	301113
1.4 mm	301114
1.5 mm	301115
1.6 mm	301116
1.7 mm	301117
1.8 mm	301118
1.9 mm	301119
2.0 mm	301120



tools

DRILLS FOR PLASTIC LENS SET

300830 // 1 piece / 86 x 10 x 53 mm / 60 g

Contains 10 drills encased in a semi-transparent plastic case.

From 0.8mm to 2.0mm.



DRILLS FOR PLASTIC LENS

1 piece

Hardened steel drills used ideally for plastic, polycarbonate and Trivex lenses.

With working speed of: 1000 to 5000 rpm.

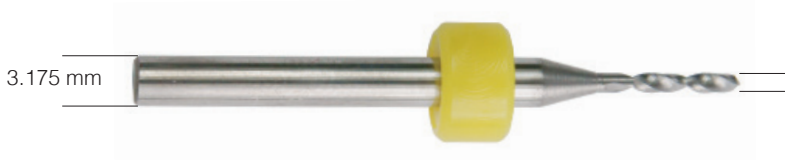

0.8 mm	300808
1.0 mm	300810
1.2 mm	300812
1.3 mm	300813
1.4 mm	300814
1.5 mm	300815
1.6 mm	300816
1.8 mm	300818
1.9 mm	300819
2.0 mm	300820



tools

MILLERS FOR PLASTIC LENS SET

300840 // 1 piece / 86 x 10 x 53 mm / 49 g

Contains 8 millers encased in a semi-transparent plastic case.

From 0.8mm to 1.6mm.



tools

MILLERS FOR PLASTIC LENS

1 piece

Hardened steel millers used on plastic, polycarbonate and Trivex lenses.



0.8 mm	300908
0.9 mm	300909
1.0 mm	300910
1.1 mm	300911
1.2 mm	300912
1.3 mm	300913
1.4 mm	300914
1.6 mm	300916

DRILL AND MILLER FOR PLASTIC LENS SET

300850 // 1 piece / 86 x 10 x 53 mm / 39 g

A 5 piece set of dual purpose drills and millers encased in a semi-transparent plastic case.

From 0.8mm to 1.6mm.



DRILL AND MILLER FOR PLASTIC LENS

1 piece

Hardened steel dual purpose drills and millers used ideally for plastics, polycarbonate and Trivex lenses.

With working speed of: 1000 to 5000 rpm.



tools

measuring devices

- 42 LENS CLOCKS
THICKNESS GAUGES
CALIPERS
- 43 TRIAL LENS SET
- 44 TRIAL FRAMES



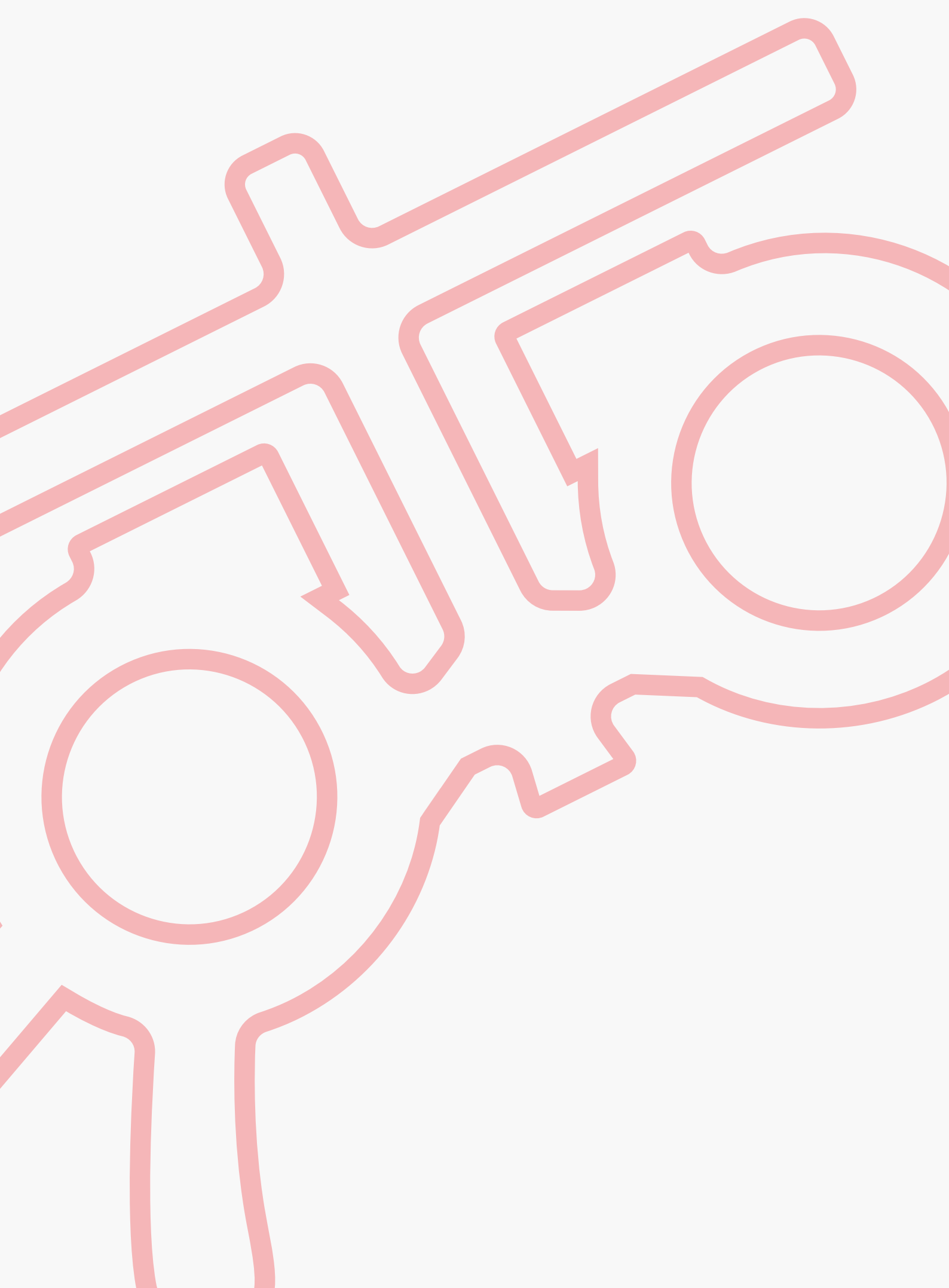

LENS CLOCK

400120 // 62 g

- Lens clock with refractive index nd 1.49 and 1.60

Measuring Scope // 0 to +/- 18 dpt



THICKNESS GAUGE

400210 // 137 x 85 x 37 mm / 162.5 g

Possible to calibrate using calibration screw

With an arm depth of 45mm

Measuring Scope // 0-10 mm

Accuracy // 0.05 mm

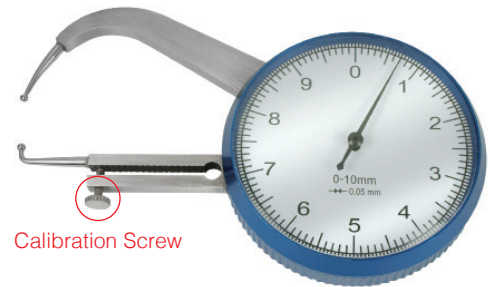

measuring
devices



DIGITAL LENS CALIPER

400310 // 235 x 78 x 15 mm / 315 g

Digital display with both "mm" and "inch" readings

Measuring Scope // 0-150 mm

Depth of Mouth // 40 mm

Power // 1.5V round cell battery



TRIAL LENS SET

with 260 pieces lens **with METAL RIMS**

400710 // 540 x 350 x 100 mm / 6.6 kg

- In high quality metal case
- Suitable for standard trial frame with 38mm lenses

Content:

39 pairs of plus (+) and minus (-) lenses

20 pairs of (+) and (-) cylinders

14 pieces of prism lenses

10 accessory lenses



TRIAL LENS SET

with 260 pieces lens **with PLASTIC RIMS**

400810 // 540 x 350 x 100 mm / 6.6 kg

- In high quality metal case
- Suitable for standard trial frame with 38mm lenses

Content:

39 pairs of plus (+) and minus (-) lenses

20 pairs of (+) and (-) cylinders

14 pieces of prism lenses

10 accessory lenses



measuring
devices

UNIVERSAL TRIAL FRAME

TF-11

- Pupil distance adjustment
 - binocular pupil distance range: 48 – 80mm
 - left and right pupil distance: 24 - 40 mm each
 - the minimum scale value: 1mm.
- Axis scale
 - left scale: 130° - 0° - 120°
 - right scale: 50° - 180° - 60°
 - the axis scale increases anticlockwise along the axis of the frame, and the marking interval is 5°
- Effective internal aperture of frame: 33.5mm
- The number of lenses that can be inserted into the left and right frames: 5 (the front is 3 and the back is 2)
- Rotation degree of optical axis of lens in inner ring of frame: 360°
- The non-parallelism between the optical axis of the lens and the geometric axis of the frame: 360°
- The difference between the optical center and the geometric center of the lens: $\leq 0.5\text{mm}$
- Displacement of the lens relative to the geometric center of the frame: $\leq 0.3\text{mm}$
- Adjustment range of nose pad:
 - adjustable length: 0 – 25mm
 - angle: arbitrary angle
- Adjustable length range of the left and right frame temple: 0 - 30mm
- Weight: 53g

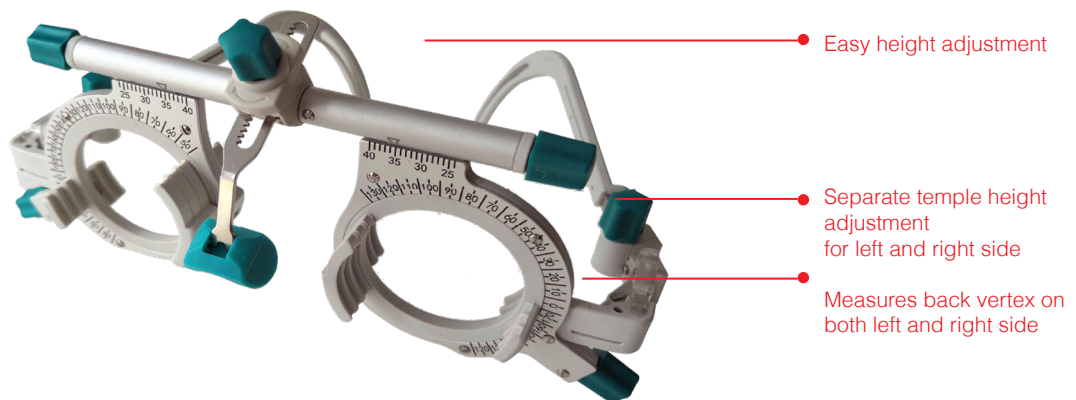

UNIVERSAL TRIAL FRAME

TF-12

- Pupil distance adjustment
 - binocular pupil distance range: 48 – 80mm
 - the minimum scale value: 1mm.
- Axis scale
 - left scale: 145° - 0° - 120°
 - right scale: 35° - 180° - 60°
 - the axis scale increases anticlockwise along the axis of the frame, and the marking interval is 5°
- The number of lenses that can be inserted into the left and right frames: 5 (the front is 3 and the back is 2)
- Adjustment range of nose pad and angle
- Adjustable length range of the left and right frame temple
- Weight: 65g

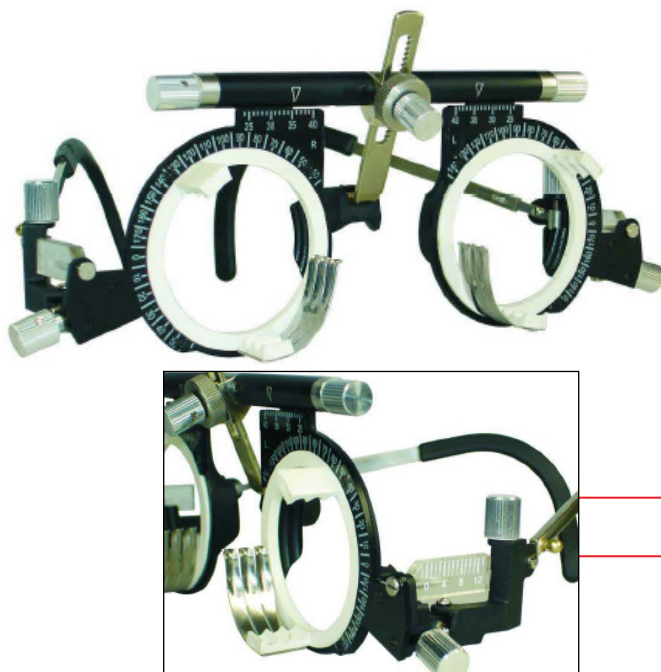

- Adjustable bridge height
- Separate PD adjustment for both left and right eye
- Adjustable left and right temple height
- Left and right side back vertex distance gauge
- Separate left and right lens axis adjustment



frame parts

NOSE PADS

- 49 NOSE PAD ASSORTMENTS
- 51 SPARE KIT WORKS FOR
RAYBAN FRAMES
- 52 SILICONE NOSE PADS WITH
PLASTIC INSERT
- 55 SILICONE NOSE PADS WITH
METAL INSERT
PRIMADORA NOSE PADS -
SILICONE
- 56 SILICONE AIR PAD CUSHIONS
- 57 SILICONE SOFT PADS
- 58 SILICONE SADDLES
- 59 SILICONE NOSE BRIDGES
WITH METAL INSERT
- 60 PVC NOSE PADS
- 62 POLYCARBONATE ULTRA
SLIM, HARD, LONG-LASTING,
DURABLE
- 63 TRANSPARENT NOSE PADS
WITH METAL INSERT-
WORKS FOR RAYBAN FRAMES
- 64 TITANIUM NOSE PADS
- 65 NOSE PADS CUSHIONS
- 67 PAD ARMS

SCREWS & NUTS

- 69 SCREW ASSORTMENTS
- 70 WASHER ASSORTMENTS
- 71 POP OFF! SCREWS
- 73 SELF-TAPING SCREWS
- 74 SELF ALIGNING SCREWS
- 75 HINGES SCREWS
- 77 NOSE PADS SCREWS
- 78 RIM JOINT SCREWS
- 79 RIMLESS FRAME SCREWS
- 80 NUTS

WASHERS & SLEEVES

- 81 WASHERS
- 82 SLEEVES
- 83 HINGES
- 86 TEMPLE TIP ASSORTMENT
- 87 TEMPLE ENDS
- 91 METAL TEMPLES
- 93 ACETATE TEMPLES
- 96 FRAME PARTS FOR RIMLES FRAMES
- 100 SILICONE NON SLIP TEMPLE ENDS
- 101 NON-SLIP EAR HOOKS
NON-SLIP TEMPLE ENDS
- 102 NYLON THREADS
LENS LINERS

NOSE PADS



Icons makes your selection easier

Material types:

Silicone

PVC

PU

Titanium

Shapes:

● Round

● Oval

● Teardrop

● D-Shape

Mounting systems:



Screw in



Push in



NOSE PAD ASSORTMENTS - 15 of the most used pads, Screw in

50610906 // 1 set / 200 x 160 x 30 mm (w x l x h)

includes:



501101-09S // 20 pairs



501102-11S // 20 pairs

501102-13S // 20 pairs

501102-14.5S // 20 pairs

501102-16.5S // 20 pairs



501103-11S // 20 pairs

501103-13S // 20 pairs

501103-14.5S // 20 pairs

501103-17S // 20 pairs



501104-13S // left & right / 40 pieces each

501104-14.5S // left & right / 40 pieces each

501104-17S // left & right / 40 pieces each



501301-19.5S // 5 pieces



501303-32S // 5 pieces



501304-44S // 5 pieces



frame parts

Customisable

.....
We can customise nose pad sets.

The contents can be
according to your needs.

For details please contact us.



NOSE PAD ASSORTMENTS - 15 of the most used pads, Push in

50610907 // 1 set / 200 x 160 x 30 mm (w x l x h)

includes:



501101-09P // 20 pairs



501102-11P // 20 pairs

501102-13P // 20 pairs

501102-14.5P // 20 pairs

501102-16.5P // 20 pairs



501103-11P // 20 pairs

501103-13P // 20 pairs

501103-14.5P // 20 pairs

501103-17P // 20 pairs



501104-13P // left & right / 40 pieces each

501104-14.5P // left & right / 40 pieces each

501104-17P // left & right / 40 pieces each



501301-19.5P // 5 pieces



501303-32P // 5 pieces



501304-44P // 5 pieces

SPARE KIT WORK FOR RAYBAN FRAMES

500101 // 1 set / 378 pieces / 178 x 105 x 23.5 mm

PVC TRANSPARENT NOSE PAD

with silver coloured metal insert

502001-15.5S // 50 pieces

PVC TRANSPARENT NOSE PAD

with gold coloured metal insert

502001-15.5G // 50 pieces

METAL TEMPLE

50710401 // silver / 3 pairs

50710402 // gold / 3 pairs

50710403 // black / 3 pairs

PAD ARM

for metal frames

502103CS // silver / 15 pairs

502103CG // gold / 15 pairs

RIM JOINT SCREW

5037091050 // silver / 50 pieces

5037092050 // gold / 50 pieces

HINGE SCREW

5036131050 // silver / 50 pieces

5036132050 // gold / 50 pieces



frame parts

Customisable

We can customise screws, washers and nuts sets.

The contents can be according to your needs.

For details please contact us.

SILICONE WITH PLASTIC INSERT - Comfortable Fit



Symmetrical // screw in

501101-09S // 50 pairs / 9 mm

501101-10.5S // 50 pairs / 10.5 mm



Symmetrical // push in

501101-09P // 50 pairs / 9 mm

501101-10.5P // 50 pairs / 10.5 mm



Symmetrical // screw in

501102-11S // 50 pairs / 11 mm

501102-13S // 50 pairs / 13 mm

501102-14.5S // 50 pairs / 14.5 mm

501102-16.5S // 50 pairs / 16.5 mm



Symmetrical // push in

501102-11P // 50 pairs / 11 mm

501102-13P // 50 pairs / 13 mm

501102-14.5P // 50 pairs / 14.5 mm

501102-16.5P // 50 pairs / 16.5 mm



Symmetrical // screw in

501103-11S // 50 pairs / 11 mm

501103-13S // 50 pairs / 13 mm

501103-14.5S // 50 pairs / 14.5 mm

501103-17S // 50 pairs / 17 mm

501103-19S // 50 pairs / 19mm



Symmetrical // push in

501103-11P // 50 pairs / 11 mm

501103-13P // 50 pairs / 13 mm

501103-14.5P // 50 pairs / 14.5 mm

501103-17P // 50 pairs / 17 mm

501103-19P // 50 pairs / 19mm

SILICONE WITH PLASTIC INSERT - Comfortable Fit



D-shape // screw in

501104-13S // 50 pairs / 13 mm

501104-14.5S // 50 pairs / 14.5 mm

501104-17S // 50 pairs / 17 mm

501104-18.5S // 50 pairs / 18.5mm



D-shape // screw in

501104-13P // 50 pairs / 13 mm

501104-14.5P // 50 pairs / 14.5 mm

501104-17P // 50 pairs / 17 mm

501104-18.5P // 50 pairs / 18.5mm

SILICONE WITH FULL SIZED PLASTIC INSERT - Comfortable Fit

Clean; dust free surfaces!

(dust doesn't stick onto surface)



Anti-dust symmetrical // screw in

501106-12.5S // 50 pairs / 12.5 mm



Anti-dust symmetrical // screw in

501106-15S // 50 pairs / 15 mm



Anti-dust symmetrical // screw in

501107-13S // 50 pairs / 13 mm



Anti-dust D-shape // screw in

501108-15S // 50 pairs / 15 mm



frame parts

SILICONE WITH PLASTIC INSERT - Comfortable Fit



Ultra slim, symmetrical // screw in
501201-12.5S // 50 pairs / 12.5 mm



Ultra slim, symmetrical // push in
501201-12.5P // 50 pairs / 12.5 mm



Ultra slim, symmetrical // screw in
501202-12.5S // 50 pairs / 12.5 mm



Ultra slim, symmetrical // push in
501202-12.5P // 50 pairs / 12.5 mm



Ultra slim, symmetrical // screw in
501203-15S // 50 pairs / 15 mm



Ultra slim, symmetrical // push in
501203-15P // 50 pairs / 15 mm



fram parts

SILICONE WITH METAL INSERT - Soft fit

Anti-dust function with soft touch



Anti-dust symmetrical // screw in // silver

501109-13SS // 50 pairs / 13 mm

501109-15SS // 50 pairs / 15 mm



Anti-dust symmetrical // screw in // gold

501109-13SG // 50 pairs / 13 mm

501109-15SG // 50 pairs / 15 mm



Anti-dust D-shape // screw in // silver

501110-13SS // 50 pairs / 13 mm

501110-15SS // 50 pairs / 15 mm



Anti-dust D-shape // screw in // gold

501110-13SG // 50 pairs / 13 mm

501110-15SG // 50 pairs / 15 mm

PRIMADORA NOSE PADS - SILICONE

Pads have a clear, plastic insert that matches any frame



Symmetrical // push in

501111-13 // 50 pairs / 13 mm



Symmetrical // push in

501113-13 // 50 pairs / 13 mm



frame parts

SILICONE AIR PAD CUSHIONS



Symmetrical // screw in

501901-13.5S // 10 pairs / 13.5 mm

501901-16S // 10 pairs / 16 mm



Symmetrical // push in

501901-14P // 10 pairs / 14 mm



Symmetrical // clip on

501902-12 // 10 pairs / 12 mm

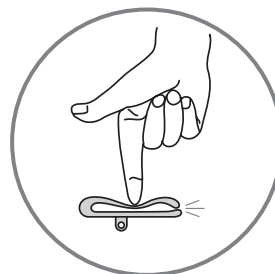

SILICONE AIR PAD CUSHIONS WITH PLASTIC INSERT



Symmetrical // screw in

501903-14.5S // 10 pairs / 14.5 mm



Symmetrical // push in

501903-14.5P // 10 pairs / 14.5 mm

SILICONE SOFT PADS-Comfortable Fit



Mushroom type, symmetrical

501401-8.5 // 50 pairs / 8.5 mm

501401-11 // 50 pairs / 11 mm



Mushroom type, symmetrical

501402-11 // 50 pairs / 11 mm

501402-12.5 // 50 pairs / 12.5 mm

501402-14.5 // 50 pairs / 14.5 mm



Mushroom type, symmetrical

501404-11 // 50 pairs / 10.5 mm



Mushroom type, symmetrical

501405-08 // 5 pairs / 8 mm



frame parts

SILICONE SADDLES WITH PLASTIC INSERT - Comfortable Fit



Silicone saddle bridge,
small type // screw in
501301-19.5S // 5 pieces / 19.5 x19 mm



Silicone saddle bridge,
small type // push in
501301-19.5P // 5 pieces / 19.5 x19 mm



Silicone saddle bridge,
junior type // screw in
501303-32S // 5 pieces / 32 x15 mm



Silicone saddle bridge,
junior type // push in
501303-32P // 5 pieces / 32 x15 mm



Silicone saddle bridge,
medium type // screw in
501304-44S // 5 pieces / 44 x14 mm



Silicone saddle bridge,
medium type // push in
501304-44P // 5 pieces / 44 x14 mm



Silicone saddle bridge,
medium type // screw in
501305-23S // 5 pieces / 23 x10 mm



Silicone saddle bridge,
medium type // screw in
501306-26S // 5 pieces / 26 x13 mm

SILICONE NOSE BRIDGES WITH METAL INSERT



501801S // 5 pieces with 10 pieces of fitting screws



501801G // 5 pieces with 10 pieces of fitting screws



501802S // 5 pieces with 10 pieces of fitting screws



501802G // 5 pieces with 10 pieces of fitting screws



501803S // 5 pieces with 10 pieces of fitting screws



501803G // 5 pieces with 10 pieces of fitting screws

501801

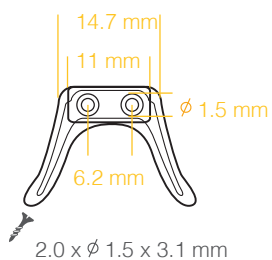

501802

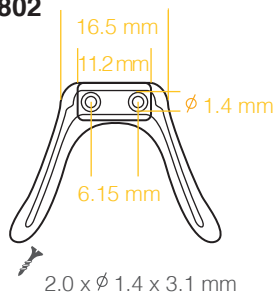

501803

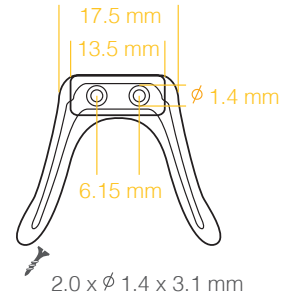

PVC TRANSPARENT WITH PLASTIC INSERT - Soft Fit

Phthalate
Free!



Symmetrical // screw in
501501-09S // 50 pairs / 9 mm



Symmetrical // push in
501501-09P // 50 pairs / 9 mm



Symmetrical // screw in
501502-12.5S // 50 pairs / 12.5 mm
501502-15S // 50 pairs / 15 mm
501502-17S // 50 pairs / 17 mm



Symmetrical // push in
501502-12.5P // 50 pairs / 12.5 mm
501502-15P // 50 pairs / 15 mm
501502-17P // 50 pairs / 17 mm



Symmetrical // screw in
501503-12.5S // 50 pairs / 12.5 mm
501503-14.5S // 50 pairs / 14.5 mm



Symmetrical // push in
501503-12.5P // 50 pairs / 12.5 mm
501503-14.5P // 50 pairs / 14.5 mm

PVC TRANSPARENT WITH PLASTIC INSERT - Soft Fit

Phthalate
Free!



D-shape // screw in

501504-14.5S // 50 pairs / 14.5 mm

501504-16.5S // 50 pairs / 16.5 mm



D-shape // push in

501504-14.5P // 50 pairs / 14.5 mm

501504-16.5P // 50 pairs / 16.5 mm

PVC SOFT PAD - Ultra Slim

Phthalate
Free!



PVC soft pad, ultra slim // screw in

501505-12S // 25 pairs / 12 mm

PVC TRANSPARENT WITH METAL INSERT - Semi Rigid

Phthalate
Free!



Symmetrical // screw in

501602-12SS / 12SG // 25 pairs / 12 mm

501602-15SS / 15SG // 25 pairs / 15 mm

501602-17SS / 17SG // 25 pairs / 17 mm



Symmetrical // push in

501602-12PS / 12PG // 25 pairs / 12 mm

501602-15PS / 15PG // 25 pairs / 15 mm

501602-17PS / 17PG // 25 pairs / 17 mm



frame parts

POLYCARBONATE ULTRA SLIM, HARD, LONG-LASTING, DURABLE



Symmetrical // screw in
501701-09S // 50 pairs / 9 mm



Symmetrical // push in
501701-09P // 50 pairs / 9 mm



Symmetrical // screw in
501702-12.5S // 50 pairs / 12.5 mm



Symmetrical // push in
501702-12.5P // 50 pairs / 12.5 mm



Symmetrical (type1) // screw in
501703-12S // 50 pairs / 12 mm



Symmetrical (type1) // push in
501703-12P // 50 pairs / 12 mm



Symmetrical (type2) // screw in
501704-13S // 50 pairs / 13 mm



Symmetrical (type2) // push in
501704-13P // 50 pairs / 13 mm



fram parts

SILICONE WITH METAL INSERT - Works for Rayban Frames

Ultra slim, allergy free, comfortable fit!



Symmetrical // clip on, silver
502004-15S // 25 pairs / 15 mm



Symmetrical // clip on, gold
502004-15G // 25 pairs / 15 mm

PVC TRANSPARENT METAL INSERT - Works for Rayban Frames



502001-15.5S // 25 pairs / 15.5 mm



502001-15.5G // 25 pairs / 15.5 mm

PVC TRANSPARENT METAL INSERT

Works for Rayban Frames



502002-14S // 5 pairs / 14 mm / silver



502002-14G // 5 pairs / 14 mm / gold



SILICONE TRANSPARENT METAL INSERT

Works for Rayban Frames



502002-16S // 5 pairs / 16 mm / silver



502002-16G // 5 pairs / 16 mm / gold



frame parts

TITANIUM NOSE PADS, Hypo-allergenic



Symmetrical // screw in
502003-13S // 3 pairs / 13 mm



Symmetrical // push in
502003-13P // 3 pairs / 13 mm



Symmetrical // screw in, gold
502003-13SG // 3 pairs / 13 mm



Symmetrical // push in, gold
502003-13PG // 3 pairs / 13 mm



Symmetrical // screw in, rose gold
502003-13SR // 3 pairs / 13 mm



Symmetrical // push in, rose gold
502003-13PR // 3 pairs / 13 mm



Symmetrical // screw in, black
502003-13SB // 3 pairs / 13 mm



Symmetrical // push in, black
502003-13PB // 3 pairs / 13 mm



fram parts

NOSE PAD CUSHIONS with retailer pack



1 Pair inside the card

Silicone-self adhesive // transparent

502102S // 10 pairs / 17.5 mm / δ 2.0 mm

502102M // 10 pairs / 17.5 mm / δ 2.3 mm

502102L // 10 pairs / 19 mm / δ 2.8 mm



NOSE PAD CUSHIONS

Silicone-self adhesive // transparent

502102S1 // 5 pairs / 17.5 mm / δ 2.0 mm

502102M1 // 5 pairs / 17.5 mm / δ 2.3 mm

502102L1 // 5 pairs / 19 mm / δ 2.8 mm



1 Pair inside the card

Silicone-self adhesive // black

502103S // 10 pairs / 17.5 mm / δ 2.0 mm

502103M // 10 pairs / 17.5 mm / δ 2.3 mm

502103L // 10 pairs / 19 mm / δ 2.8 mm



NOSE PAD CUSHIONS

Silicone-self adhesive // black

502103S1 // 5 pairs / 17.5 mm / δ 2.0 mm

502103M1 // 5 pairs / 17.5 mm / δ 2.3 mm

502103L1 // 5 pairs / 19 mm / δ 2.8 mm

NOSE PAD CUSHIONS with Retailer Pack in Display



Logo customisation possible
For details please contact us

50210200 // transparent

/ 30 Pairs, 10 Pairs per size

502102S

502102M

502102L

50210300 // black

/ 30 Pairs, 10 Pairs per size

502103S

502103M

502103L



frame parts

NOSE PAD CUSHIONS



Silicone - self adhesive

▶||| Thickness = 0.7mm

502101-13 // 20 pieces / 13 mm

502101-15 // 20 pieces / 15 mm

502101-17 // 20 pieces / 17 mm

502101-19 // 20 pieces / 19 mm

Silicone - self adhesive

▶||| Thickness = 1.0mm

502102-13 // 20 pieces / 13 mm

502102-15 // 20 pieces / 15 mm

502102-17 // 20 pieces / 17 mm

502102-19 // 20 pieces / 19 mm

NOSE PAD CUSHIONS with retailer pack

2 Pairs inside the card



Silicone-self adhesive

▶||| Thickness = 0.7mm

502101-13R // 20 pairs / 13 mm

502101-15R // 20 pairs / 15 mm

502101-17R // 20 pairs / 17 mm

502101-19R // 20 pairs / 19 mm

Silicone-self adhesive

▶||| Thickness = 1.0mm

502102-13R // 20 pairs / 13 mm

502102-15R // 20 pairs / 15 mm

502102-17R // 20 pairs / 17 mm

502102-19R // 20 pairs / 19 mm

NOSE PAD CUSHIONS with retailer pack in display box



50210100 // 60 Pairs

includes:

502101-13R // 10 Pairs

502101-15R // 20 Pairs

502101-17R // 20 Pairs

502101-19R // 10 Pairs

50210400 // 60 Pairs

includes:

502102-13R // 10 Pairs

502102-15R // 20 Pairs

502102-17R // 20 Pairs

502102-19R // 10 Pairs

Logo customisation possible
For details please contact us

NOSE PAD CUSHIONS, ROUNDED SURFACE



Length



Thickness



Silicone - self adhesive // Transparent

502105-15 // 20 pieces		15mm		2.0mm
502105-1701 // 20 pieces		17mm		2.0mm
502105-1702 // 20 pieces		17mm		3.0mm
502105-1901 // 20 pieces		19mm		2.0mm
502105-1902 // 20 pieces		19mm		3.0mm

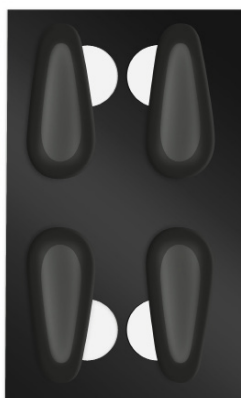

Silicone - self adhesive // Black

502105-1703 // 20 pieces		17mm		2.0mm
---------------------------------	--	------	--	-------



Packing Suggestion

PAD ARMS FOR METAL FRAMES - Nickel Free

503804...

Standard type



502101SS // 5 pairs



502101SG // 5 pairs

Works for Rayban frames (clipon)



502103CS // 5 pairs



502103CG // 5 pairs



502102PS // 5 pairs



502102PG // 5 pairs

Conjoined type *



502104S // 5 pairs



502104P // 5 pairs

* Please contact with us for MOQ



frame parts

SCREWS



Icons makes your selection easier

Screws for:

 Nose Pads

 Rim Joints

 Hinges

 Rimless Frames

Shapes:

 Slotted Screw

 Phillips Screw

 Hexagon Screw / Nut

 Torx Screw

 Star Screw / Nut

Measurements:

 Thread size

 Thread length

 Total length

 Head diameter

 Diameter

 Outer diameter



SCREW ASSORTMENTS

18 of most used rimless frame screws, nuts, washers and sleeves

50611000 // 1 set / 1800 pieces / 200 x 160 x 30 mm

RIMLESS FRAME SCREWS

slotted screw

50310110100 // silver / 100 pieces

50310120100 // gold / 100 pieces

50310510100 // silver / 100 pieces

50310520100 // gold / 100 pieces

RIMLESS NUTS

star nut

50410110100 // silver / 100 pieces

50410120100 // gold / 100 pieces

50410310100 // silver / 100 pieces

50410320100 // gold / 100 pieces

RIMLESS CAPS

50330140100 // transparent / 100 pieces

50330240100 // transparent / 100 pieces

WASHERS

50510340100 // transparent / 100 pieces

50510640100 // transparent / 100 pieces

50510110100 // silver / 100 pieces

50510120100 // gold / 100 pieces

50510410100 // silver / 100 pieces

50510420100 // gold / 100 pieces

DOUBLE SLEEVES

5032104050 // transparent / 100 pieces

5032074050 // transparent / 100 pieces

Customisable

We can customise screws, washers and nuts sets.

The contents can be according to your needs.

For details please contact us.





SCREW ASSORTMENTS

7 of the most used screw and nut
50610600 // 1 set / 700 pieces
 / 86.8 x 86.8 x 20 mm

SELF ALIGNING SCREWS

for Spring Hinges
50340420100 // 100 piece
50340210100 // 100 piece

RIM JOINT SCREWS

50370410100 // 100 piece
50370710100 // 100 piece

NOSE PAD SCREWS

50380410100 // 100 piece

HINGE SCREWS

50360610100 // 100 piece

RIMLESS NUTS

50410310100 // 100 piece

WASHER ASSORTMENTS

7 of the most used washer
50610800 // 1 set / 700 pieces
 / 86.8 x 86.8 x 20 mm

WASHER, PLASTIC, TRANSPARENT

50510340100 // 100 piece
50510640100 // 100 piece

WASHER, BRASS

50510410100 // 100 piece
50510420100 // 100 piece
50510120100 // 100 piece
50510110100 // 100 piece

WASHER, BRASS, SILVER

with conical head
50510210100 // 100 piece



fram parts

Customisable

We can customise screws, washers and nuts sets.

The contents can be according to your needs.

For details please contact us.

POP OFF! SCREWS with SELF-TAPPING THREAD

Material: Steel / 50 pieces

With blue coating on the thread only, with extra long conical ending.

Made of steel, available colours:
silver, gold and gun

Simple to mount due to a
conical tip

Blue screw securer offers
a firm grip

Easy to shorten by
snapping

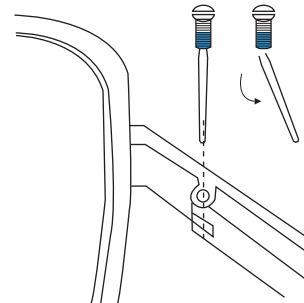
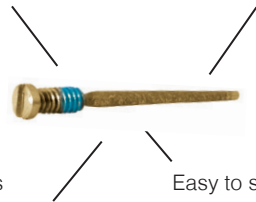

				5039011050					
				5039012050	1.0 mm		12.8 mm	2.8 mm	1.4 mm
				5039013050					

				5039021050					
				5039022050	1.2 mm		14.8 mm	4.8 mm	1.8 mm
				5039023050					

				5039031050					
				5039032050	1.3 mm		14.8 mm	4.8 mm	1.8 mm
				5039033050					

			5039042050					
			5039043050	1.4 mm		13 mm	3 mm	1.8 mm

				5039051050					
				5039052050	1.4 mm		14.8 mm	4.8 mm	1.8 mm
				5039053050					



frame parts



fram parts

		5039061050 5039062050 5039063050		1.5 mm		14 mm		4 mm		1.8 mm
--	--	--	--	--------	--	-------	--	------	--	--------

		5039071050 5039072050 5039073050		1.5 mm		14.8 mm		4.8 mm		1.8 mm
--	--	--	--	--------	--	---------	--	--------	--	--------

		5039081050 5039082050 5039083050		1.4 mm		13.5 mm		3.5 mm		2.0 mm
--	--	--	--	--------	--	---------	--	--------	--	--------

		5039091050 5039092050 5039093050		1.4 mm		14 mm		4 mm		2.0 mm
--	--	--	--	--------	--	-------	--	------	--	--------

		5039101050 5039102050 5039103050		1.4 mm		14.8 mm		4.8 mm		2.0 mm
--	--	--	--	--------	--	---------	--	--------	--	--------

		5039111050 5039112050 5039113050		1.5 mm		14 mm		4 mm		2.0 mm
--	--	--	--	--------	--	-------	--	------	--	--------

		5039121050 5039122050 5039123050		1.5 mm		14.8 mm		4.8 mm		2.0 mm
--	--	--	--	--------	--	---------	--	--------	--	--------

SELF-TAPPING SCREWS with TRANSPARENT SECURER

Material: Steel / 50 pieces

Made of steel, available colours: silver and gold

Transparent nylon inlay

Self tapping thread

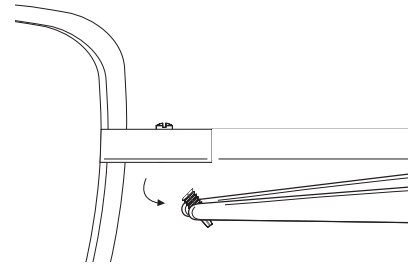

 **5035011050**

 **5035012050**



1.3 mm



11.5 mm



1.8 mm



 **5035021050**

 **5035022050**



1.4 mm



11.5 mm



1.8 mm



 **5035031050**

 **5035032050**



1.5 mm



11.5 mm



1.8 mm

SELF-TAPPING SCREWS FOR HINGE ON PLASTIC FRAME

Material: Stainless Steel / 50 pieces

Easily fixable tool on plastic frames

Made of stainless steel, available colours: silver



Coarse thread especially for plastic

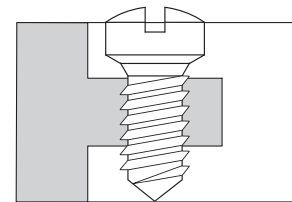

 **5035041050**



1.6 mm



6 mm



2.5 mm



 **5035051050**



1.4 mm



4.9 mm



2 mm



frame parts

SELF ALIGNING SCREWS for Spring Hinges

Material: Steel / 100 pieces

Made of steel, available colours: silver, gold and gun



Easy to shorten by snapping

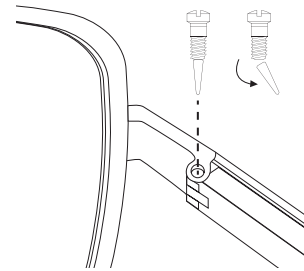

 50340110100

 50340120100

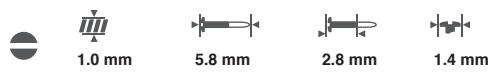

 50340210100

 50340220100

 50340230100

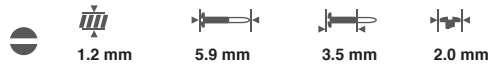

 50340310100

 50340320100

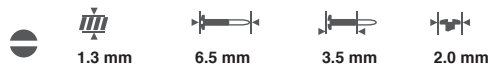

 50341010100

 50341030100

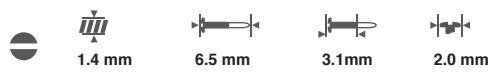

works for Rayban frames



 50340910100

 50340920100

 50340930100

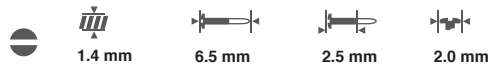

 50340410100

 50340420100

 50340430100

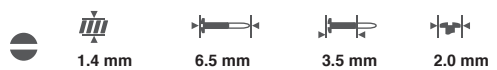



50340510100
50340520100

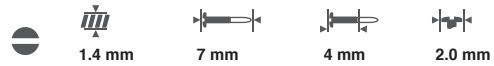

50340610100
50340620100

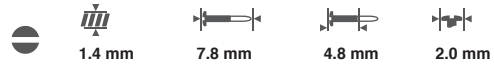

50340710100
50340720100



50340810100
50340820100



HINGE SCREWS

Material: Steel / 100 pieces

Made of steel, available colours: silver and gold

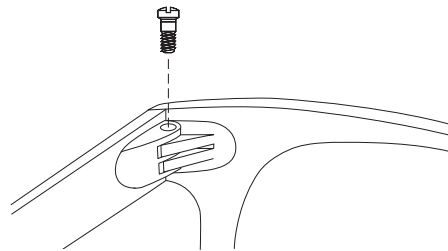

50361610100

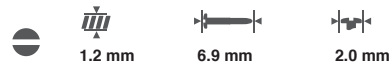

works for Rayban frames



50360110100

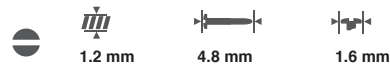

50360210100

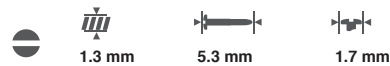

5036131050 / 50 pieces



5036132050 / 50 pieces

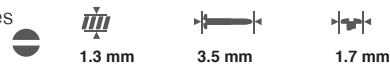

works for Rayban frames



50360310100



50360320100



50360410100





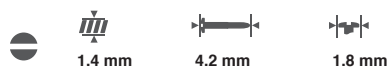



















50360420100



frame parts















































fram parts

 	 50360510100  50360520100		 1.4 mm	 5.0 mm	 1.8 mm
	 50360610100		 1.4 mm	 8.6 mm	 2.8 mm
	 50360710100		 1.4 mm	 11.4 mm	 2.8 mm
 	 50360810100  50360820100		 1.5 mm	 5 mm	 1.8 mm
	 50360910100		 1.5 mm	 10 mm	 2.8 mm
 	 50361010100  50361020100DB		 1.6 mm	 5.2 mm	 1.8 mm
	 50361110100DB		 1.6 mm	 9 mm	 2.8 mm
	 5036141050 / 50 pieces		 1.6 mm	 4.0mm	 2.5 mm <i>works for Rayban frames</i>
	 5036151050 / 50 pieces		 1.6 mm	 4.6mm	 2.5 mm <i>works for Rayban frames</i>
	 50361710100 / 100 pieces		 1.2 mm	 3.0mm	 2.0 mm
	 50361810100 / 100 pieces		 1.2 mm	 3.5mm	 2.0 mm
	 50361910100 / 100 pieces		 1.2 mm	 4.0mm	 2.0 mm
	 50362010100 / 100 pieces		 1.4 mm	 3.0mm	 2.0 mm
	 50362110100 / 100 pieces		 1.4 mm	 3.5mm	 2.0 mm
	 50362210100 / 100 pieces		 1.4 mm	 4.0mm	 2.0 mm

NOSE PAD SCREWS

Material: Steel / 100 pieces

	 50380110100		 0.8 mm	 3.7 mm	 1.0 mm
	 50380210100		 1.0 mm	 3.8 mm	 1.8 mm
	 50380220100				
	 50380310100DB		 1.0 mm	 4 mm	 1.2 mm
	 50380410100				
	 50380420100				
	 50380430100		 1.0 mm	 4 mm	 1.4 mm
	 50380510100				
	<i>with stay tight thread lock coating</i>				
	 50380610100		 1.0 mm	 4.45 mm	 1.4 mm
	 50380710100		 1.1 mm	 4.2 mm	 1.3 mm



S000029

Packaging Suggestion.
Please find our frame parts
organizer on Page 122



S000030

Packaging Suggestion.
Please find our frame parts
organizer on Page 122



frame parts

RIM JOINT SCREWS

Material: Steel / 100 pieces



50370110100
50370120100

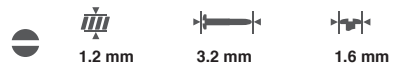

50370210100

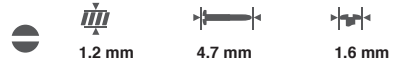

5037091050 / 50 pieces
5037092050 / 50 pieces

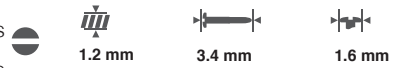

works for Rayban frames



50370310100



50370910100

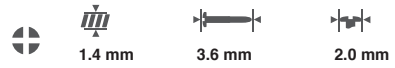

works for Rayban frames



50371010100

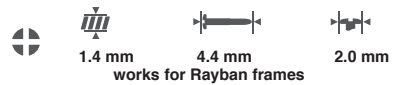

works for Rayban frames



50371110100

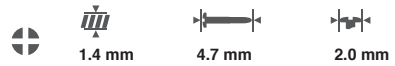

works for Rayban frames



50370410100
50370420100
50370430100

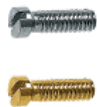
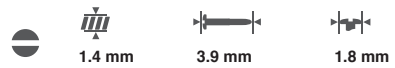

50370510100
50370520100

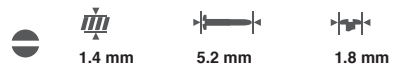

50370610100

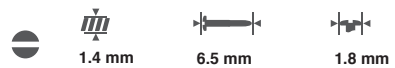

50370710100
50370720100

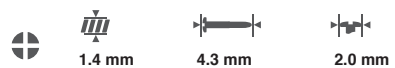

50370810100

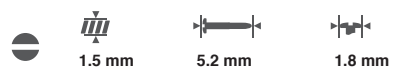

fram parts

RIMLESS FRAME SCREWS

Material: Steel / 100 pieces

	 50310110100DB  50310120100	  1.2 mm  15 mm  1.8 mm
	 50310210100  50310220100	  1.2 mm  10.7 mm  2.5 mm
	 50310310100DB  50310320100DB	  1.2 mm  12 mm  2.5 mm
	 50310410100  50310420100	  1.2 mm  12.6 mm  2.5 mm
	 50310810100	  1.4 mm  2.7 mm  2.5 mm <i>works for Rayban frames</i>
	 50310910100	  1.4 mm  3.0 mm  2.5 mm <i>works for Rayban frames</i>
	 50310510100DB  50310520100DB	  1.4 mm  15 mm  1.8 mm
	 50310610100  50310620100  50310630100	  1.4 mm  12 mm  2.5 mm
	 50310710100  50310720100	  1.4 mm  12.6 mm  2.5 mm



frame parts

RIMLESS NUTS

Material: Brass / 100 pieces



 50410110100

 50410120100

 50410130100



 2.5 mm

 1.2 mm



 50410210100



 2.5 mm

 1.3 mm





 50410310100

 50410320100

 50410330100



 2.5 mm

 1.4 mm



 50410410100



 2.5 mm

 1.5 mm



 50410510100



 2.5 mm

 1.6 mm

RIMLESS DOME NUTS

Material: Brass / 100 pieces



 50420110100

 50420120100



 2.4 mm

 1.2 mm



 50420210100

 50420220100



 2.4 mm

 1.2 mm



 50420310100

 50420320100



 2.4 mm

 1.4 mm



 50420410100

 50420420100

 50420430100



 2.4 mm

 1.4 mm





fram parts

WASHERS

Material: Brass / 100 pieces



-  **50510110100**
-  **50510120100**
-  **50510130100**



 2.5 mm ϕ 1.2 mm



-  **50510210100**
with conical head

 2.8 mm ϕ 1.2 mm



-  **50510410100**
-  **50510420100**
-  **50510430100**

 2.5 mm ϕ 1.4 mm



-  **50510510100**
with conical head

 2.8 mm ϕ 1.4 mm

Material: Plastic Transparent / 100 pieces



-  **50510340100**

 2.5 mm ϕ 1.2 mm



-  **50510640100**

 3.0 mm ϕ 1.4 mm

PLASTIC SLEEVES for Rimless Frames

Material: Plastic / Transparent / 100 pieces



-  **50320140100**

 2.8 mm ϕ 1.2 mm



-  **50320240100**



 2.8 mm ϕ 1.4 mm

RIMLESS CAPS

Material: Plastic / Transparent / 100 pieces





-  **50330140100**

ϕ 2.5 mm  1.2 mm  3.5 mm



-  **50330240100**

ϕ 3.0 mm  1.2 mm  3.5 mm



DOUBLE SLEEVES for Rimless Frames

Plastic Soft Material / 50 pieces



 **5032044050**



 **5032054050**
open version

∅ 1.4 mm



 **5032064050**



 **5032104050**

∅ 1.8 mm

Plastic Medium-Soft Material / 50 pieces



 **5032034050**
open version

∅ 1.3 mm



 **5032094050**

∅ 1.5 mm

Plastic Hard Material / 50 pieces



 **5032074050**

∅ 1.4 mm



 **5032084050**

∅ 1.5 mm



 **5032114050**
open version

∅ 1.8 mm

SINGLE SLEEVES for Rimless Frames

Plastic Hard Material / 50 pieces



 **5032124050**

∅ 1.5 mm



 **5032134050**

∅ 1.8 mm

RIM LOCKS

// 10 pieces + 10 



51010201

 1.4 mm

 2.4 mm

 4.0 mm



51010301

 1.4 mm

 2.4 mm

 4.5 mm

SOLDER HINGES

 1.4 mm



50910101
left front part // 10 pieces + 10 



50910102
right front part // 10 pieces + 10 



50910103
temple part // 10 pieces



50910201
left front part // 10 pieces + 10 



50910202
right front part // 10 pieces + 10 



50910203
temple part // 10 pieces



50910301
for flex sides, Left // 10 pieces + 10 



50910302
for flex sides, right // 10 pieces + 10 



50910401
for flex sides, Left // 10 pieces + 10 



50910402
for flex sides, right // 10 pieces + 10 

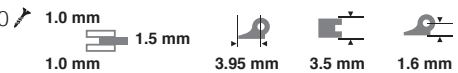

50910501
left front part // 10 pieces + 10 



50910502
right front part // 10 pieces + 10 



50910503
temple part // 10 pieces



frame parts

PINNED HINGES

 2.5 mm
  1.4 mm
  2.5 mm
  1.2 mm



50920101

left temple part // 10 pieces + 10 



50920102

right temple part // 10 pieces + 10 







50920103

left front part // 10 pieces

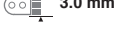

50920104

right front part // 10 pieces

 0.8 mm
 1.0 mm
 3.0 mm
 6°



50920201

left temple part // 10 pieces + 10 







50920202

right temple part // 10 pieces + 10 

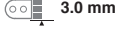

50920203

front part // 10 pieces

 0.9 mm
 1.2 mm
 3.0 mm
 0°



50920301

left temple part // 10 pieces + 10 



50920302

right temple part // 10 pieces + 10 







50920303

left front part // 10 pieces

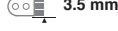

50920304

right front part // 10 pieces

 0.9 mm
 1.4 mm
 3.5 mm
 6°



50920401

left temple part // 10 pieces + 10 



50920402

right temple part // 10 pieces + 10 



50920403

left front part // 10 pieces



50920404

right front part // 10 pieces









50920405

left front part // 10 pieces

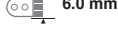

50920406

right front part // 10 pieces

 1.3 mm
 1.2 mm
 1.3 mm
 0.8 mm
 0.8 mm
 6.0 mm
 6°

HIDDEN HINGES

 1.4 mm

	50930101 round plate // 10 pieces	 1.0 mm	 5.0 mm	 2.5 mm	
	50930201 round plate // 10 pieces	 1.2 mm	 5.0 mm	 2.5 mm	
	50930301 round plate // 10 pieces	 1.4 mm	 5.0 mm	 2.5 mm	
	50930401 oval plate with nylon insert // 10 pieces	 1.3 mm	 4.4 mm	 3.2 mm	
	50930501 square plate // 10 pieces	 1.4 mm	 3.5 mm	 2.24 mm	
	50930601 for front or temple // 10 pieces	 1.6 mm	 3.5 mm	 3.15 mm	
	50930701 oval plate // 10 pieces	 1.6 mm	 1.6 mm	 7.0 mm	 3.2 mm
	50930801 for flexible joint sides left // 10 pieces + 10 	 0.8 mm	 1.2 mm	 2.8 mm	 3.2 mm
	50930802 for flexible joint sides right // 10 pieces + 10 	 0.8 mm			
	50930901 for flexible joint sides left // 10 pieces + 10 	 0.9 mm	 1.2 mm	 3.3 mm	 0.6 mm
	50930902 for flexible joint sides right // 10 pieces + 10 	 0.9 mm			
	50931001 for flexible joint sides left // 10 pieces + 10 	 1.0 mm	 1.5 mm	 4.5 mm	 3.2 mm
	50931002 for flexible joint sides right // 10 pieces + 10 	 1.0 mm			

SINGLE RIVET

Nickle Silver / 50 pieces



 **5032141050**

 1.18 mm  10 mm



frame parts

ACETATE TEMPLE ENDS

Classic Style // 5 pairs

∅ 1.2 mm / 65 mm



50620101
50620102
50620103
50620104
50620105

∅ 1.45 mm / 65 mm

50620106
50620107
50620108
50620109
50620110

∅ 1.6 mm / 69.5 mm



50620201
50620202
50620203
50620204
50620205

∅ 1.4 mm / 75 mm



50621001
50621002
50621003

∅ 1.6 mm / 70 mm



50621105
50621106
50621107



frame parts

ACETATE TEMPLE ENDS

Thin Style // 5 pairs

∅ 0.9 mm / 69.5 mm



50620501

50620502

50620503

∅ 1.0 mm / 135 mm

∅ 1.2 mm / 135 mm



50620701

50620702

50620703

50620704

∅ 1.7 mm / 65 mm



50620901

50620902

50620903

50620904

∅ 1.9 mm / 65 mm



50620905

50620906

50620907

50620908



fram parts

ACETATE TEMPLE ENDS

Golf Style // 5 pairs

∅ 1.2 mm / 65 mm

∅ 1.45 mm / 65 mm



50620301

50620306

50620302

50620307

50620303

50620308

50620304

50620309

50620305

50620310

Modern Style // 5 pairs

∅ 1.6 mm / 65 mm



50620401

50620402

50620403

50620404

50620405

Long Style // 5 pairs

∅ 1.45 mm / 135 mm

∅ 1.2 mm / 135 mm



50620601

50620604

50620602

50620605

50620603

50620606

Symmetrical Shape // 5 pairs

∅ 1.7 mm / 65 mm



50620801

50620802

50620803

50620804



frame parts

ACETATE TEMPLE ENDS

Golf Style // 5 pairs

Small Opening Style // 5 pairs



∅ 1.1 mm / 68.8 mm

∅ 1.0 mm / 66.5 mm

50621301

50621201



50621302

50621202

50621303

50621203



∅ 1.1 mm / 66 mm



50621403



50621404

SILICONE TEMPLE ENDS

Small round opening // 5 pairs

∅ 0.9 - 1.1 mm / 67 mm



50622101



50622102

50622103



Rectangular opening // 5 pairs

∅ 1.5 - 1.0 mm / 61mm



50622201



50622202

50622203



METAL TEMPLES - Nickel Free

1 pair / \varnothing 1.4 mm / 140 mm

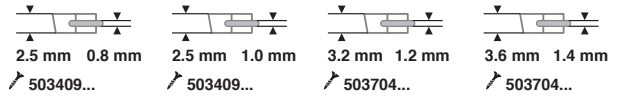

- | | | | |
|----------|----------|----------|----------|
| 50710301 | 50710306 | 50710311 | 50710316 |
| 50710302 | 50710307 | 50710312 | 50710317 |
| 50710303 | 50710308 | 50710313 | 50710318 |
| 50710304 | 50710309 | 50710314 | 50710319 |
| 50710305 | 50710310 | 50710315 | 50710320 |

1 pair / \varnothing 1.4 mm / 145 mm



- | |
|----------|
| 50710401 |
| 50710402 |
| 50710403 |
| 50710404 |



METAL FLEX TEMPLES - Nickel Free

1 pair / \varnothing 1.4 mm / 140 mm / \square 2.2 mm

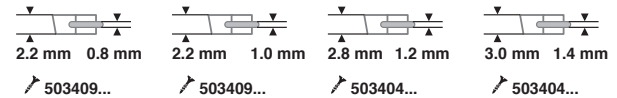

- | | | | |
|----------|----------|----------|----------|
| 50710201 | 50710206 | 50710211 | 50710216 |
| 50710202 | 50710207 | 50710212 | 50710217 |
| 50710203 | 50710208 | 50710213 | 50710218 |
| 50710204 | 50710209 | 50710214 | 50710219 |
| 50710205 | 50710210 | 50710215 | 50710220 |



frame parts

METAL FLEX TEMPLS - Nickel Free

1 pair / $\overline{1.4}$ mm / 140 mm / $\overline{2.3}$ mm

3.0 mm  0.9 mm

 503404...



50710501



50710502



50710503





50710504





50710505



1 pair / $\overline{1.4}$ mm / 140 mm /  503404...

3.3 mm 0.8 mm
 $\overline{2.8}$ mm

3.3 mm 1.0 mm
 $\overline{2.8}$ mm

3.5 mm 1.2 mm
 $\overline{3.0}$ mm

3.5 mm 1.4 mm
 $\overline{3.0}$ mm



50710601

50710606

50710611

50710616



50710602

50710607

50710612

50710617



50710603

50710608

50710613

50710618



50710604

50710609

50710614

50710619



50710605

50710610

50710615

50710620

fram parts

ACETATE FLEX TEMPLS

1 pair / \varnothing 1.4 mm / 140 mm / \square 4.5 mm



3.0 mm  1.0 mm

 503404...

50720101

50720102

50720103

50720104

1 pair / \varnothing 1.4 mm / 140 mm / \square 4.5 mm



3.5 mm  1.0 mm

 503404...

50720201

50720202

50720203

50720204



frame parts

ACETATE FLEX TEMPLES

1 pair / \bar{w} 1.4 mm / 140 mm / \bar{c} 4.5 mm

5.0 mm  1.2 mm

 503405...



50720301



50720302



50720303



50720304

1 pair / \bar{w} 1.4 mm / 140 mm / \bar{c} 4.5 mm

6.3 mm  1.2 mm

 503405...



50720401



50720402



50720403



50720404

fram parts

ACETATE FLEX TEMPLES

1 pair / \overline{w} 1.4 mm / 140 mm / \overline{d} 4.5 mm



9.0 mm  1.2 mm

 503405...

50720501

50720502

50720503

50720504

1 pair / \overline{w} 1.4 mm / 140 mm / \overline{d} 4.2 mm



10 mm  1.4 mm

 503406...

50720601

50720602

50720603

50720604



frame parts

SPARE PART KIT SET FOR RIMLESS FRAMES ASSORTMENTS

Set for rimless frames includes temples / double sleeves / temple tips / metal bridges and Silicone nose pads

50730000 // 1 set / 200 x 160 x 30 mm



fram parts

TEMPLE FOR RIMLESS FRAMES

with double sleeves and temple tips

507301010 // 1 set

507301020 // 1 set

507301030 // 1 set

507301040 // 1 set

507301050 // 1 set

507301060 // 1 set

DOUBLE SLEEVES

5032074050 // 16 pieces

METAL BRIDGE FOR RIMLESS FRAMES

50180401 // 1 piece

50180402 // 1 piece

50180403 // 1 piece

50180404 // 1 piece

50180405 // 1 piece

50180406 // 1 piece

SILICONE NOSE PADS

501402-12.5 // 20 pieces

Customisable



The contents can be according to your needs.

For details please contact us.

SPARE PARTS SET FOR RIMLESS FRAMES

1 set including Temple, Bridge, Nose Pads, Double sleeves, Temple tips

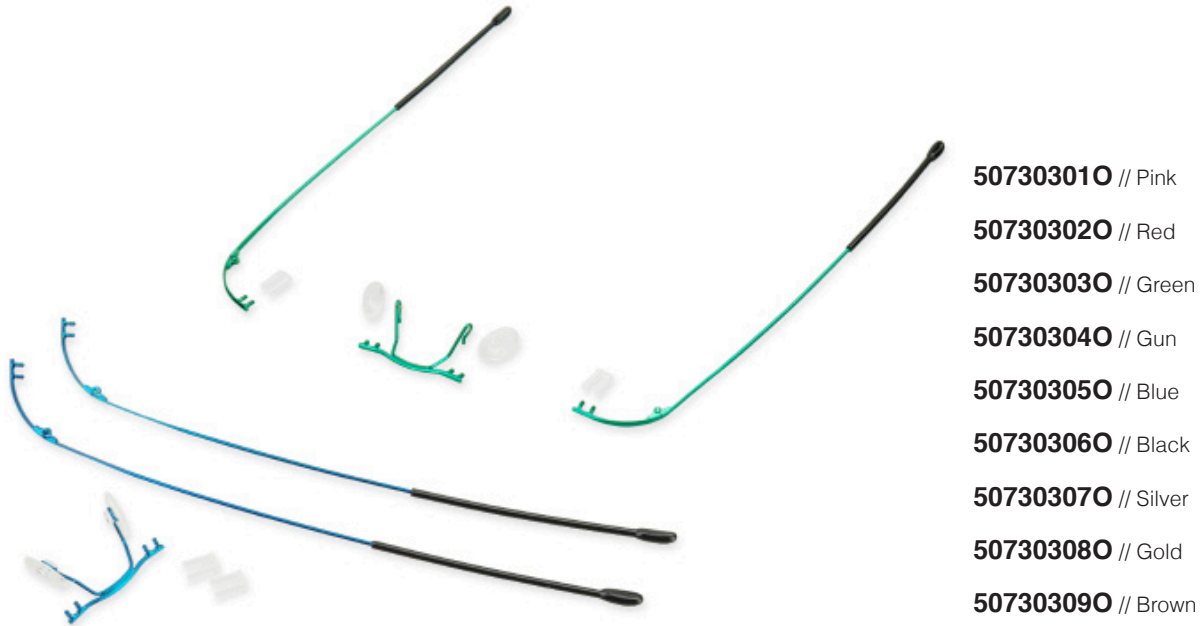

METAL TEMPLES - Nickel Free

Monoblock Temple for Rimless Frames With Sleeve Mount // 1 pair / 140 mm

- SKU + O Means is matched with 1 pair double sleeves and 1 pair temple tips

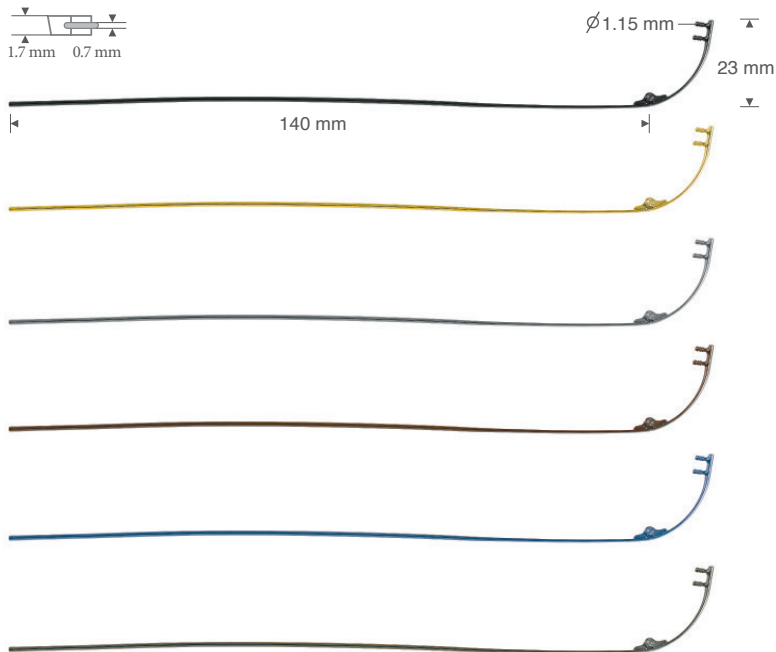

Matched Parts

50621201 / 50621202 / 50621203

5032054050 / 5032094050 / 5032074050

WITHOUT Matched Parts

WITH Matched Parts

black	50730101 // 50730101O
gold	50730102 // 50730102O
silver	50730103 // 50730103O
brown	50730104 // 50730104O
blue	50730105 // 50730105O
gun	50730106 // 50730106O



frame parts

METAL TEMPLES - Nickel Free

Monoblock Temple for Rimless Frames With Sleeve Mount // 1 pair / 140 mm

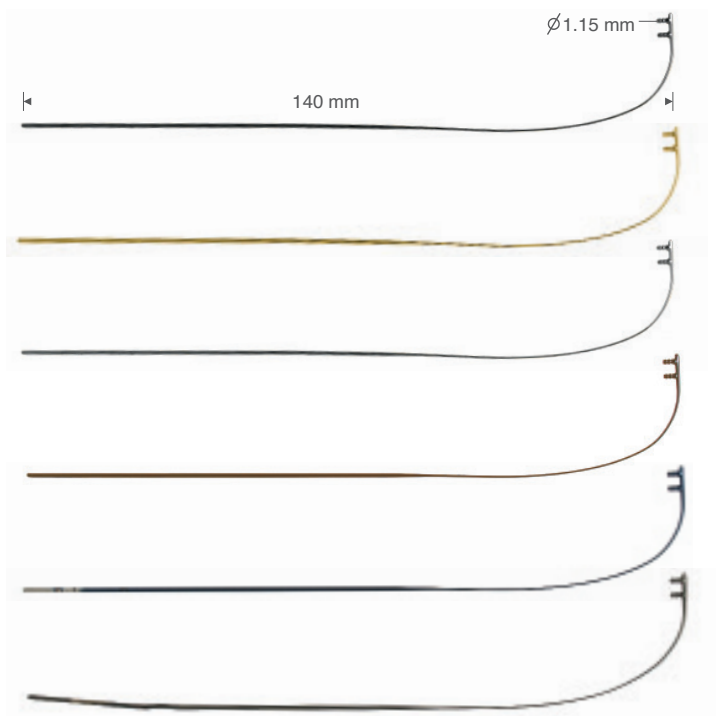

Matched Parts

50621201 / 50621202 / 50621203

5032054050 / 5032094050 / 5032074050

WITHOUT
Matched Parts

WITH
Matched Parts

black **50730201 // 50730201O**

gold **50730202 // 50730202O**

silver **50730203 // 50730203O**

brown **50730204 // 50730204O**

blue **50730205 // 50730205O**

gun **50730206 // 50730206O**

fram parts

Bright Look! Temple for Rimless Frames with sleeve Mount // 1pair / 140mm

- With double sleeves 2pcs and temple tips 1 pair

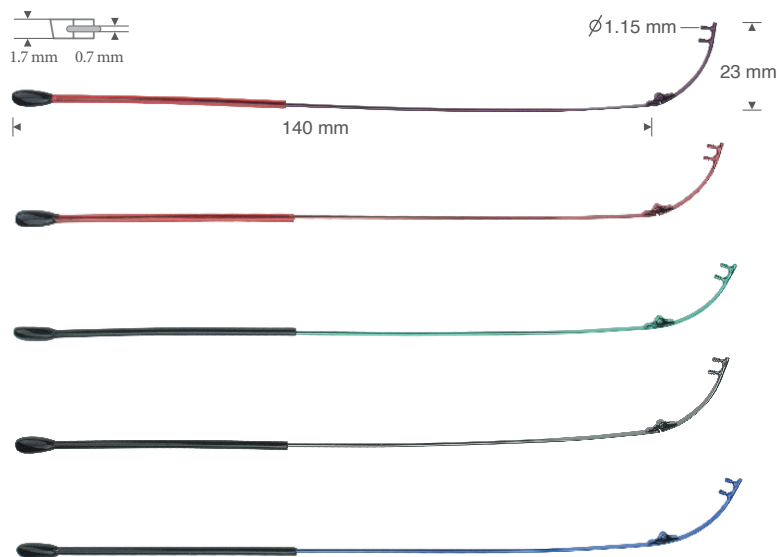

50730301 // Pink

50730302 // Red

50730303 // Green

5w0730304 // Gun

50730305 // Blue

METAL BRIDGES - Nickel Free

Bridge for Rimless Frames // 1 piece

- SKU+O means is matched with nose pads 1 pair and double sleeves 2pcs

Matched Parts

0 501402-12.5

5032054050 / 5032094050 / 5032074050

WITHOUT Matched Parts

WITH Matched Parts

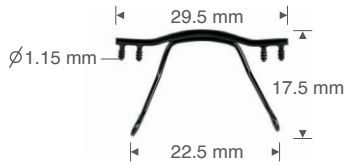

WITHOUT Matched Parts

WITH Matched Parts

black **50180401** // **50180401O**



silver **50180403** // **50180403O**



gold **50180402** //

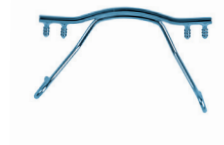

brown **50180404** // **50180404O**



50180402O



blue **50180405** // **50180405O**

gun **50180406** // **50180406O**

METAL BRIDGES - Nickel Free

Bright Look! Spare parts set for Rimless frame // 1 set / 140 mm

- With nose pads 1 pair and double sleeves 2pcs.

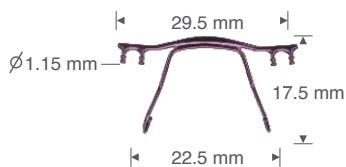

50180501 // Pink



50180504 // Gun



50180502 // Red



50180505 // Blue



50180503 // Green



frame parts

SILICONE NON SLIP TEMPLE ENDS

// 25 pairs

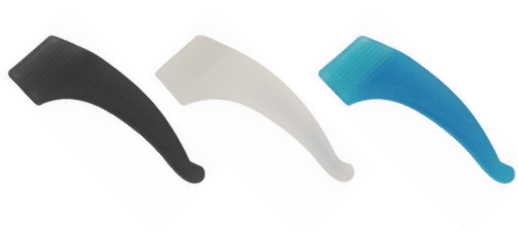

- 50610101
- 50610102
- 50610103



5.9 mm

2.7 mm

- 50610201
- 50610202
- 50610203



2.8 mm

1.8 mm

SILICONE NON SLIP TEMPLE ENDS

with retailer pack, bigger size // 10 pairs



- 50610101R
- 50610102R
- 50610103R

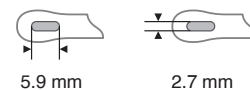

5.9 mm

2.7 mm

SILICONE NON SLIP TEMPLE ENDS

with retailer pack, small size // 10 pairs



- 50610201R
- 50610202R
- 50610203R



2.8 mm

1.8 mm



fram parts

NON-SLIP EAR HOOKS

60623100 // 18.5 * 17.5 mm / 6 pairs (2 pieces per color) TPE Material 



NON-SLIP TEMPLE ENDS

Dia 14 mm / 10 pairs

60623201 // Silicone, Annular, Transparent

60623202 // Silicone, Annular, Black



60623301 // Silicone, Round two slot sizes, Transparent

60623302 // Silicone, Round two slot sizes, Black



frame parts

NYLON THREADS

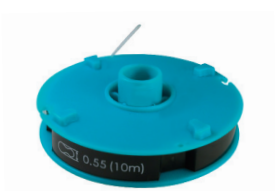

8 Shape // 10 M / roll

50810101 0.55 mm

50810102 0.51 mm



T Shape // 5 M / roll

50810201 1.3 mm

50810202 2.0 mm



Round // 20 M / roll

50810301 0.5 mm

50810302 0.6 mm

NYLON THREAD SETS

50810000

A comprehensive set of 5 nylon threads that cater for basic needs.

50810101 10M / roll 0.55 mm

50810201 5M / roll 1.3 mm

50810202 5M / roll 2.0 mm

50810301 20M / roll 0.5 mm

50810302 20M / roll 0.6 mm

50810001

A comprehensive set of 6 nylon threads that cater for basic needs.

50810101 10M / roll 0.55 mm

50810102 10M / roll 0.51 mm

50810201 5M / roll 1.3 mm

50810202 5M / roll 2.0 mm

50810301 20M / roll 0.5 mm

50810302 20M / roll 0.6 mm



LENS LINERS

with thickness 0.25mm

50910000 // 4M / roll



with thickness 0.5mm

50920000 // 3M / roll



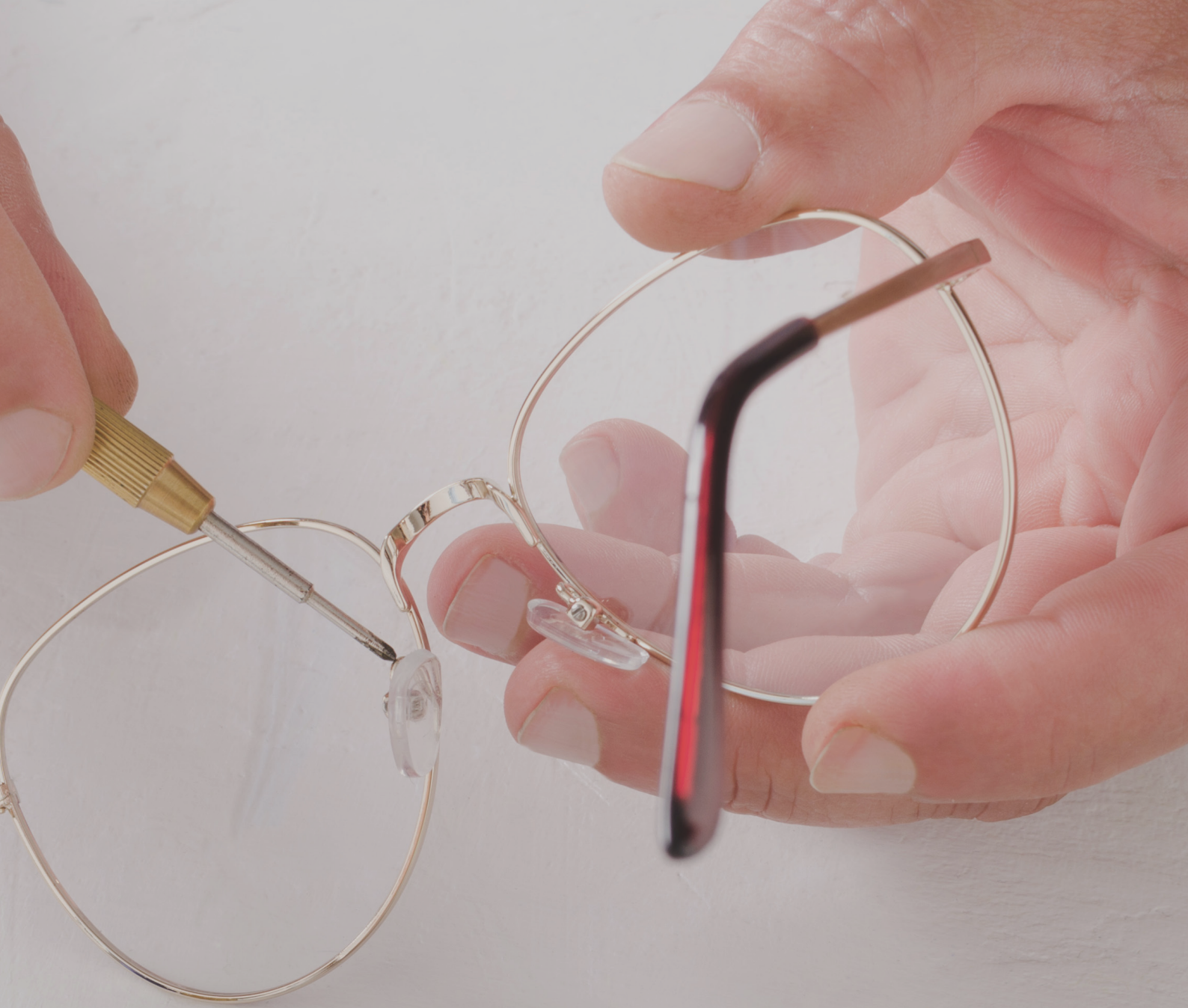

essentials.



Rua Padre Francisco nº11G
1350-223 Lisboa
Tel. +351 213 616 580 Fax +351 213 616 589
prooptica@prooptica.pt
Visite-nos em:
Website: www.prooptica.pt
Loja Online: www.online.prooptica.pt

prooptica®
full eyewear concept